



**HÖGSKOLAN I BORÅS**  
INSTITUTIONEN INGENJÖRSHÖGSKOLAN

**Implementation of an Electrical  
Bioimpedance Monitoring System  
and a Tool for Bioimpedance  
Vector Analysis**

DAVID IBÁÑEZ SORIA

---

FINAL DEGREE THESIS 30 ECTS, ERASMUS 2007-08 SWEDEN

THESIS N° 5/2008, BIOMEDICAL ENGINEERING

---



# **Implementation of an Electrical Bioimpedance Monitoring System and a Tool for Bioimpedance Vector Analysis**

**David Ibáñez Soria**

*Final Degree Thesis*

Subject Category: **Technology**

Series Number **Communication and Programming 2007-08**

**University College of Borås**

**School of Engineering**

**SE-501 90 BORÅS**

**Telephone +46 33 435 4640**

Examiner: **Dr. Fernando Seoane Martínez**

Supervisor: **Dr. Fernando Seoane Martínez**

Client: **Högskolan i Borås**

Date: **2008 May 30th**



## ***ABSTRACT***

---

Electrical Bioimpedance Measurements have been proved to constitute an appropriate method for assessment of body composition, and therefore they can provide with direct indicators of body fluid distribution. Such ability of EBI technology allows the detection of body fluid unbalance caused by renal dysfunction, and therefore, nephrology teleconsultations would benefit tremendously from EBI measurements.

Bioimpedance Vector Analysis has been proved to be one of the most popular techniques nowadays for Bioimpedance analysis.

This project is based on the AD5933 Impedance Network Analyzer of Analog Devices, and the main task is to develop a software application that controls the evaluation board in which it is implemented; and allows the storage of the EBI measurements in EDF files that will facilitate the management of medical data.

Another tool based in has been created Matlab in order to analyse the recording data according to the Bioimpedance Vector Analysis



## ***PREFACE***

---

This final degree work has been done in Borås, Sweden, during the course 2007/2008 under the European Exchange Program Socrates in execution of the Erasmus agreement between Högskolan I Borås and Universidad de Alcalá de Henares, and more specifically the agreement between the Institutionen Ingenjörshögskolan and the Escuela Universitaria de Ingeniería de Telecomunicación. The project work has been supervised by Dr. Fernando Seoane Martinez.





## ***ACKNOWLEDGEMENTS***

---

En primer lugar me gustaría expresar mi más sincero agradecimiento a mi supervisor, Fernando Seoane, ya que sin su apoyo y conocimiento este trabajo hubiera sido imposible de realizar.

También me gustaría agradecer el apoyo de Lexa Nescolarde y Antonio Piccoli por las facilidades mostradas a la hora de compartir sus estudios e investigaciones, presentes en este proyecto.

Por último me gustaría dedicar este trabajo a mis padres por apoyarme siempre en cada decisión tomada, a mi hermano y su mujer por su comprensión en todo momento y por supuesto al resto de familia y amigos que siempre me han dado apoyo y comprensión.



## TABLE OF CONTENTS

---

<b>CHAPTER 1.....</b>	<b>13</b>
<b>INTRODUCTION .....</b>	<b>13</b>
1. 1 Introduction .....	13
1.2 Motivation .....	13
1. 3Work Done .....	13
1.4 Out of Scope .....	14
<b>CHAPTER 2.....</b>	<b>15</b>
<b>bioimpedance analysis.....</b>	<b>15</b>
<b>2.1 Electrical Properties of the Biological Tissue .....</b>	<b>15</b>
2.1.1. Antecedents of Electrical Bioimpedance Measurement .....	15
2.1.2. Electrical Bioimpedance Definition.....	16
2.1.3. Electrical properties of Biological Tissues .....	17
2.1.4. Equivalent circuit model for a single cell .....	19
2.1.5. Resultant Parameters of BIA.....	19
2.1.5. Variables Calculated from BIA.....	22
<b>CHAPTER 3.....</b>	<b>25</b>
<b>Measurements of bioimpedance &amp; instrumentation .....</b>	<b>25</b>
3.1 Bioimpedance Measurement .....	25
3.1.1. Measurement types.....	26
3.1.2. Measurement Techniques.....	26
3.2.1 Voltage Generation and Excitation.....	28
3.2.2 Current Sensing Stage.....	29
3.2.3 Impedance Estimation.....	29
3.2.4 Frequency Sweep .....	30
3.2.3 Calibration.....	31
3.3 Standardization in data storage: EDF+ files .....	33
<b>CHAPTER 4.....</b>	<b>37</b>
<b>Software application.....</b>	<b>37</b>
4.1 Introduction .....	37
4.2 Software application functions .....	38
4.3.1. Calibration.....	38
4.3.1.1. Automatic Calibration.....	38
4.3.1.2. Point to Point Calibration.....	39
4.3.2. Single Measurements .....	39
4.3.3. Multi Measurements.....	39
4.3.4. Data Record.....	39
4.3.5 Patient Selection .....	40
4.3.6. Data Representation .....	40
4.4. Bioimpedance Measurement Application .....	40
4.4.1 Calibration Panel.....	41
4.4.2 Sweep Single Panel.....	44
4.4.3 Sweep Continuous Panel.....	48
4.4.4 Patient Panel.....	50
<b>CHAPTER 5.....</b>	<b>53</b>
<b>BIOIMPEDANCE VECTOR ANALYSIS.....</b>	<b>53</b>
5.1. Bases of BIVA .....	53
5.1.1. BIVA Statistics .....	53
5.1.2. RXc Graph .....	54
5.1.2. RXc Score Graph .....	55
5.1.3 BIVA Interpretation .....	56
5.2 BIVA Implementation .....	59
5.2.1 Data Used .....	59

5.2.2 <i>Implementing the Ellipses</i> .....	60
<b>CHAPTER 6</b> .....	<b>63</b>
<b>MATLAB BASED BIVA</b> .....	<b>63</b>
6.1. Matlab Based BIVA .....	63
6.2 Evaluation BIVA Panel .....	64
6.3 BIVA EDF APPLICATION.....	66
6.4 Matlab Subroutines.....	70
6.4.1. <i>Open EDF Files</i> .....	70
6.4.2. <i>Drawing Ellipses</i> .....	71
6.4.3. <i>Implementing RXc Score Graph</i> .....	71
6.4.4. <i>Implementing RXc Graph</i> .....	71
<b>CHAPTER 7</b> .....	<b>73</b>
<b>MATLAB RESULTS</b> .....	<b>73</b>
7.1. RXc Score Graph.....	73
7.2 RXc Graph.....	74
7.2.1 <i>Men Non-Hispanic White RXc Graph</i> .....	74
7.2.2 <i>Women Non-Hispanic White RXc Graph</i> .....	75
7.2.3 <i>Men Non-Hispanic Black RXc Graph</i> .....	76
7.2.4 <i>Women Non-Hispanic Black RXc Graph</i> .....	77
7.2.5 <i>Men Mexican RXc Graph</i> .....	78
7.2.6 <i>Women Mexican RXc Graph</i> .....	79
<b>CHAPTER 8</b> .....	<b>81</b>
<b>discussion and future</b> .....	<b>81</b>
8.1 Discussion.....	81
8.2. Future.....	82

---

## ***CHAPTER 1***

---

### ***INTRODUCTION***

#### **1. 1 Introduction**

This project is focused on the implementation of an electrical multi frequency Bioimpedance Measurement system that is able to achieve single recordings as well as multi recordings and saves the measured data in a standardised data format. EDF+.

The measurement system is also completed with an application for the data analysis including the Bioimpedance vector analysis technique.

#### **1.2 Motivation**

Bioimpedance analysis for body composition is a well spread technique that is still being developed nowadays.

Electrical Bioimpedance Measurements have been proved to be an appropriate method for assessment of body composition, and therefore they can provide with direct indicators of body fluid distribution. Such ability of Electrical Bioimpedance technology allows the detection of body fluid unbalance caused by renal dysfunction and the diagnosis of a big amount of diseases such as anorexia, oedema, cancer or cholera. These features make this method suitable for a big number of medical applications.

#### **1. 3Work Done**

A biomedical measurement system has been developed based in the AD5933 Impedance Network Analyzer plus and adapting analog front end developed in [Ferreira and Sánchez].

A full measurement software application adapted for Electrical Bioimpedance measurements has been developed. The functionality of the application allows multi-frequency measurements and continuous monitoring without the need of system calibration each time the software is run. The EBI data is stored in a standardised data format, EDF.

An application for EBI data analysis that complements the application for EBI measurements has been implemented as well. The chosen method for analysing the data was BIVA (BioImpedance Vector Analysis).

The combination of both systems produces a complete measurement and analysis bioimpedance system.

## **1.4 Out of Scope**

In every biomedical application, one of the most important factors is the safety of the patient. The Bioimpedance measurement system implemented in this project introduces an alternating current in the patient's body during the excitation stage. Therefore, it would be necessary to introduce an isolation block between the electrodes and the measurement system that protected the patient from any damage caused by the electrical injection, specially considering that the system can be connected to the general electric network. But this part of the system has not been implemented in this project.

Some measurements over human body have been done to check the viability of the work with successful results, but this application is not save enough for testing it in patients with several illness that the system should be able to detect or evaluating the body water unbalanced along a time.

Also because of this reason the comparison of the system with a commercial one used in hospitals was not possible.

## **CHAPTER 2**

---

### **BIOIMPEDANCE ANALYSIS**

## **2.1 Electrical Properties of the Biological Tissue**

### **2.1.1. Antecedents of Electrical Bioimpedance Measurement**

The history of Electrical Bioimpedance measurements in biological tissues date back to the end of XVIII century, with the experiments carried out by Galvani. Electrical Bioimpedance measurements give information about the tissue, as long as the event under analysis presents a change in structure, size or composition. It was not until the beginning of XX century when the structure of biological tissues was studied focusing on their passive electrical properties, what proved that biological tissues are conductors and their impedance changes with frequency.

Basically Electrical Bioimpedance measurements can be classified within two types. One is the study of the Bioimpedance changes over time that are associated to a physiological or pathophysiological process e.g. Impedance cardiography that studies the circulatory system or impedance anemography that monitors the respiration. The objective of this application is to find qualitative and quantitative information about the changes of impedance produced by composition or structural changes. The second type pursues the determination of characteristics of the body tissues, such as: hydration, oedema, volume of body fluids, intra and extracellular volume, fat percentage, and in general terms, the state of the tissues and the cells composing them.

The instrumentation used in Bioimpedance measurement is very affordable. Besides, it uses a non-ionizing technique that can be applied non-invasively. These facts have encouraged its possible application in several areas. However, this measurement is influenced by many factors, including the geometry, the tissue conductivity and the blood flow, among others. Using multiple electrodes (typically 16) it is possible to obtain enough conductivity data about the volume to generate images of a body section, what is called Electrical Impedance Tomography or Bioimpedance Tomography, but its

spatial resolution is very poor in comparison with other medical imaging modalities currently in use.

Electrical Impedance Spectroscopy is used for the characterization of healthy and pathological tissues based on spectrum of their electrical properties. This approach is popular nowadays because spectral measurement provides with much more information about the tissue than a single frequency measurement.

### 2.1.2. Electrical Bioimpedance Definition

The Electrical Impedance of a material is the opposition that the material offers to the flow of electrical charges through it. If the material is of biological origin, then such opposition is called Electrical Bioimpedance.

The impedance ( $Z$ ) is a complex number defined by Ohm's law as the ratio between the measured voltage ( $V$ ) and the total current flow ( $I$ ).

Due to the nature of tissues, the impedance may vary with the frequency of measuring signal. The impedance will decrease as the frequency increases. The relationship between the impedance and frequency is non-linear. The higher the frequency, the lower is the impedance.

In the case of a homogeneous and isotropic object, the impedance is a function of its electrical properties (conductivity and permittivity), but also depends on geometric factors determined by the cell factor.

$$Z = k \frac{1}{\sigma + jw\epsilon_0\epsilon_r} = k \frac{1}{\sigma^*} = k\rho^* = k(r + jx) = k \left| \rho^* \right|_{\text{phase}(\rho^*)} \quad (2.1)$$

Where:

- k = Cell Factor (m-1)
- $\sigma$  = electrical conductivity (S/m)
- j = imaginary symbol
- w = frequency
- $\epsilon_0$  = permittivity of vacuum
- $\epsilon_r$  = relative permittivity



Instead of using the complex conductivity ( $\sigma^* = \sigma + j\omega\epsilon_0\epsilon_r$ ), we can define the complex impedivity ( $\rho^* = r + jx$ ). The real part of the impedivity is the resistivity and the imaginary part is the reactivity.

Historically, impedance measurements were expressed as resistivity, due to the small magnitude of the imaginary part, which is not considered. This is a correct approximation, especially at low frequencies (1 kHz or lower). However, at high frequencies the imaginary part increases and the impedivity must be considered as a complex number. As the term impedivity is not commonly used, we will use the term specific impedance and its polar representation ( $|Z|$  magnitude and  $\Phi$  phase angle). The previous equations are only valid in the case of a homogeneous and isotropic object.

### 2.1.3. Electrical properties of Biological Tissues

Living organisms are composed by cells. Therefore, the cell is defined as the fundamental unit of life. Most cells are joined to each other by means of an extracellular matrix or by direct adhesion of one cell to the other constituting different unities. These cell associations give rise to the tissues.

The main component of the cells is their cellular membrane, the structure of which is based on a lipid double layer in which proteins are distributed, allowing the formation of channels to exchange ions with the exterior, *Figure 2.1*. Due to its molecular components, the cellular membrane acts as a dielectric interface and can be considered as the two plates of a capacitor.

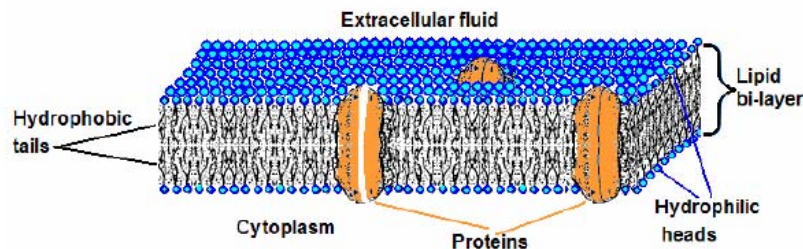

Figure 2.1. Cellular membrane diagram

Therefore, when a constant electric field is applied, the electrically charged ions move and accumulate in both sides of the membrane. However, when the field is alternating, an alternating movement of electrons appears at both sides of the cellular wall, producing a relaxation phenomenon.

The dielectric relaxation phenomenon in the tissues is the result of the polarization of several dipoles and the movement of the charges that induce a permittivity and conductivity phenomenon. The charge carriers are mainly ions and the main source of dipoles are the water polar molecules in the tissues.

The electrical behaviour of biological tissues reveals a dependency of the dielectric parameters with the current frequency, due to the different relaxation phenomena that take place when the current flows through the tissue.

When the frequency of the applied electric field increases, the conductivity of most of the tissues rises from a low value in direct current, which depends on the extracellular volume, to a constant level that keeps between 10 and 100 MHz.

This increase in conductivity is associated to a decrease in permittivity, from a high value at low frequency, in four relaxation windows:  $\alpha$ ,  $\beta$ ,  $\delta$  and  $\gamma$ , as it is shown in *Figure 2.2*. Each of these steps characterizes a type of relaxation that occurs in a specific frequency range and is characteristic for each tissue.

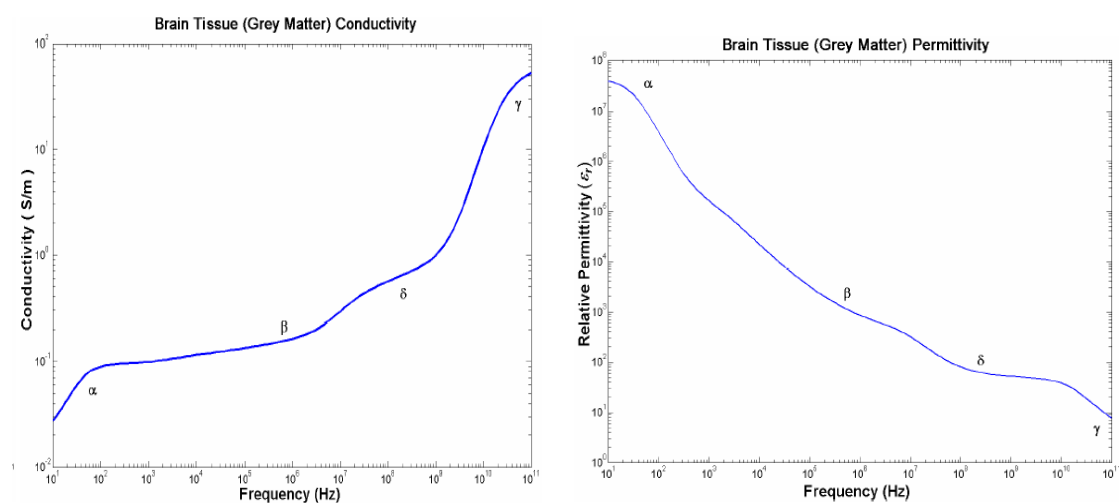

**Figure 2.2.** Ideal representation of permittivity and conductivity in Brain tissue (grey matter) as a function of the frequency.

### 2.1.4. Equivalent circuit model for a single cell

A cell can be characterized by a model that can explain its electrical behaviour. Electrically the intra-cellular and extra-cellular fluid acts as a resistance, respect  $R_i$  and  $R_e$ . The cell membrane acts as a membrane resistance  $R_m$  parallel to a membrane capacitor  $C_m$ . In this circuit several approximations can be done in order to achieve an easy functional system like the shown in the figure.

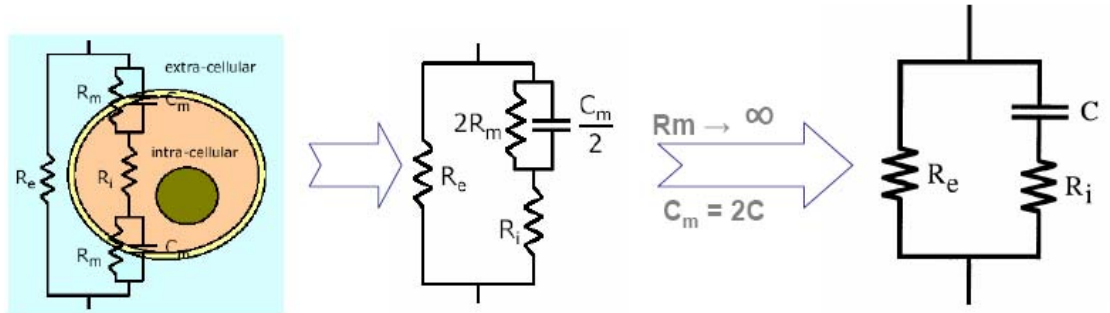

Fig 2.3 Electrical cell model and following approximations until reach the Fricke Cell Model

The impedance of a cell follows the following equation.

$$Z(\omega) = \frac{R_e(1 + jR_iC\omega)}{1 + jC\omega(R_i + R_e)} \quad (2.2)$$

### 2.1.5. Resultant Parameters of BIA

The impedance is represented by a complex number, and can be expressed in the complex impedance plane according to  $Z=R+jX$ . In the human body the reactance is negative.

Resistance R is the pure resistance of a conductor to alternating current and is therefore inversely proportional to total body water. Because of the high proportion of water and electrolytes, the lean body mass is a good conductor of electrical current whereas the fat mass has a high resistance. If a resistance measurement is very much above the normal range, as may arise with very low water content, then the body water and therefore the lean body mass will tend to be too low.

Reactance  $X_c$  is the resistance which a condenser exerts to an alternating current. All cell membranes of the body act like mini-condensers due to their protein-lipid layers. The reactance is therefore a measure of the body cell mass.

Differentiation and determination of both of these components of impedance is possible by measuring the phase angle. The principle of measurement is based upon the fact that the condensers in the alternating current circuit lead to a time delay. Every metabolically active cell of the body has an electrical potential difference at the cell membrane of about 50-100 mV. This membrane potential allows the cell to act in an alternating electrical field like a spherical condenser. The phase angle is most meaningful at a frequency of 50 kHz. A pure cell membrane mass would have a phase angle of 90 degrees, pure electrolyte water has a phase angle of 0 degrees.

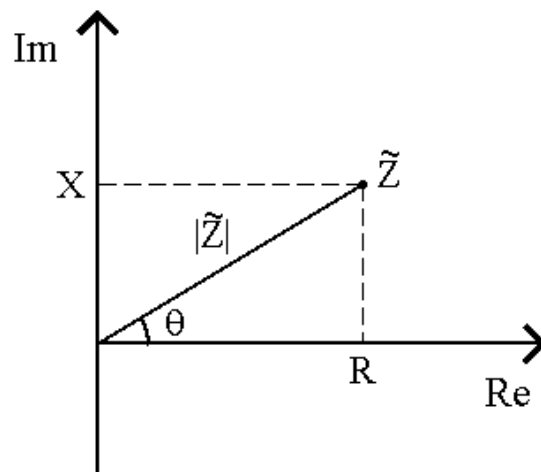

**Fig 2.4. Impedance sample in normal axis as the sum of the real part and the imaginary part**

The resistance of a biological conductor is also dependent of the frequency used and a differentiation between low and high frequencies can be done.

Low frequencies in the range of 1 to 5 KHz are hardly able to overcome to cell membranes. They are, therefore only able to propagate in the extra-cellular mass and contain practically no reactance component. For this reason these frequencies can be used selectively for calculating the extra-cellular water [BIA compendium].

With increasing frequency, the phase angle increases and as such the capacitive resistance (reactance); the maximum is reached about 50 KHz. In this moment a slight

deflection at the membrane occurs. That is why at frequencies around 50Khz measurements of total body water and body cell mass can be estimated.

High frequencies over 100 KHz causes a no deflection in the cell membrane so measurements of total body water can be estimated.

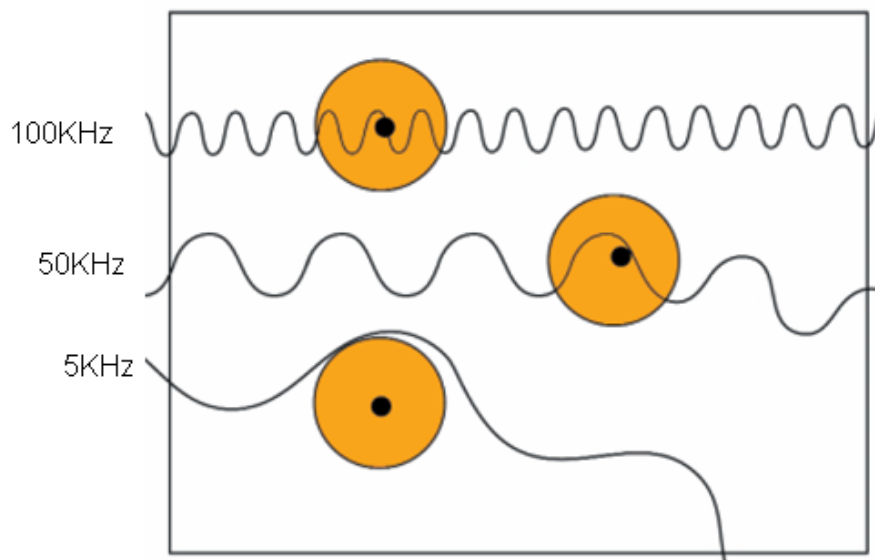

Fig 2.5 Conductivity pathways of different frequencies in a tissue

This relationship between frequencies and resistances was described by Cole, and the graphical representation Cole Plot.

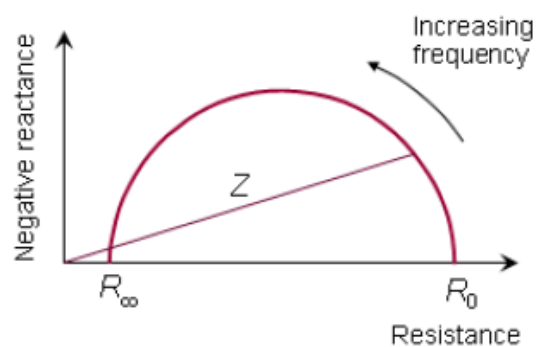

Fig 2.6. Cole-Cole Plot

Variations in mass of the extra-cellular mass and the body cell mass can be assessed using multi-frequency analysis to provide better differentiation with regard to cell loss of water displacement.

Multi-frequency analysis is particularly advantageous in patients with an altered degree of hydration in the lean body mass and in illnesses, in which monitoring of water balance is particularly important.

### 2.1.5. Variables Calculated from BIA

Through bioimpedance measurements several body components can be estimated.

#### Total Body Water (TBW)

It is possible to determine the electrolyte water contained in the tissue very exactly. Water which is orally ingested and has been not yet absorbed by the body is not measured in this analysis, whereas external administered solutions are.

The amount of body water in an individual is determined first of all via the body cell mass and therefore primarily via the muscle mass. In order to detect accumulated water other parameters are necessary: a raised ECM/BCM index and a lowered percentage cell fraction are an indication of water deposition. The TBW is primarily dependent on the amount of body cell mass (a high muscle mass leads to a high amount of water, whereas people with asthenic body build have little total body water) [3].

The typical distribution in a healthy subject of total body water is a 43% of extra-cellular component and a 57% of an intra-cellular component.

#### Lean Body Mass (LBM)

The body mass is the tissue mass of the body that contains no fat. The lean body mass is made up primarily of the muscles, the inner organs, the skeletal system and the central nervous system [3].

According to Pace and Rathburn (1945), the lean body mass has a water content of 73%. The lean body mass is consequently derived from the body water. For a healthy hydrated subject it can be calculated as:

$$LBM = \frac{TBW}{0.73} \quad (2.3)$$

#### Body Fat (BF)

Fat acts as an insulator to alternating current. Fat cells do not possess the typical property of the cells of the body cell mass and therefore have hardly any capacitive resistance. The fat mass is calculated as the difference between the lean body mass and the body weight [3].

### Body Cell mass (BCM)

The body cell mass is the sum of all cells actively involved in the metabolic processes. Each tissue of the human organism contains a certain proportion of the BCM. Connective tissue with low fibrocyte content contains only a small percentage of the entire BCM, whereas the muscles have a high percentage and, therefore constitute the largest part of the BCM.

The BCM includes the following types of tissues: the cells of skeletal muscle system, the cardiac muscles, the smooth muscles, the inner organs, the gastrointestinal tract, the blood, the glands and the nervous system. [3]

BCM is the central parameter in the assessment of the nutritional state of a patient, as all metabolic work in the body is carried out within the cells of the BCM. A genuine loss in the BCM is only in the case, if at the same time [3].

- The phase angle goes down
- The reactance drops and/or
- The cell density falls in %

### Extra-Cellular Mass (ECM)

The part of the lean body mass outside the cells of the BCM is described as the extra-cellular mass. Fixed constituents of the ECM are the connective tissue structures: collagen, elastin, skin, tendons, fasciae and bones. The ECM/BCM is a very important parameter for assessing nutritional status. In healthy individuals, the body cell mass is always distinctly than the extra-cellular fluid mass, so the index is smaller than one.





## CHAPTER 3

### MEASUREMENTS OF BIOIMPEDANCE & INSTRUMENTATION

#### 3.1 Bioimpedance Measurement

Electrical impedance is the opposition to the flow of an electrical current, being the ratio between an alternating sinusoidal voltage and an alternating sinusoidal flow. In consequence impedance is a passive magnitude that does not irradiate energy, therefore energy must be provided in two ways: by exciting the tissue with current or with voltage.

In this case, the EBI measurement method used consists on injecting an electrical signal with a known current and measuring the reciprocal complementary voltage magnitude the value is calculated using the Ohm's Law, in the frequency domain.

$$Z = \frac{V}{I} \tag{3.1}$$

Where Z is the impedance, V the voltage and I the current.

The diagram block of a typical impedance measurement system is the following:

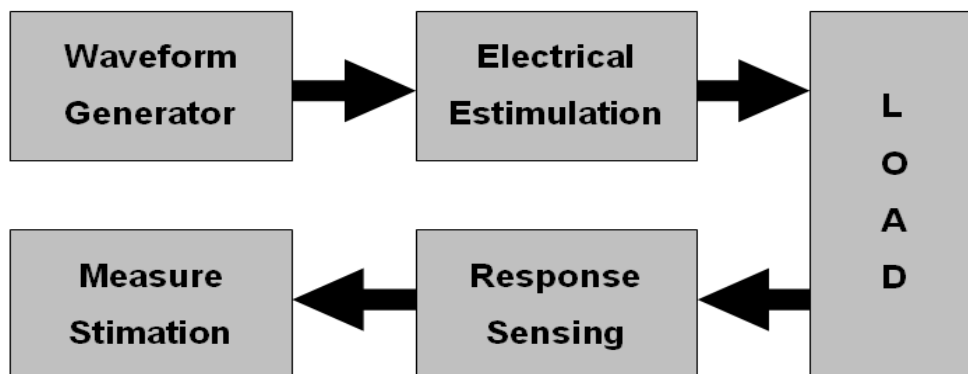

Fig.3.1. Typical diagram block of a impedance measurement system

### 3.1.1. Measurement types

Depending on the type of information that we are looking for analyse several types of measurements can be done.

**Non-phase BIA measurement:** This method measures the total resistance of the body ( $Z$ ). This does not give determination of the phase angle and, as such, a subdivision of impedance into water and cellular resistance, so that no judgement can be made about the body cell mass or the extra-cellular mass with non-phase measurements

**Phase BIA measurement:** The phase sensitive technique of measuring allows the impedance  $Z$  to be differentiated into its two components resistance ( $R$ ), that shows the water resistance, and reactance ( $X_c$ ), that show the cell resistance. This let us differentiate between the body cell mass and extra-cellular mass.

**Phase BIA multi-frequency measurement:** BIA is frequency dependent, therefore for a more intensive study we can study the resistance and reactance in a different single low frequencies measurements (1-5 KHz). With this type of measurement it is possible to achieve a subdivision of the total body water into intra-cellular and extra-cellular body water.

### 3.1.2. Measurement Techniques

There are several approaches to measure Bioimpedance that should be chosen depending on the desired characteristics of the system built.

**Null Techniques:** Detection with this technique is very simple and it is based in a simple ampere meter. The most common method used is a Wheatstone bridge.

This is a high accurate method with the inconvenient of needing a large number of electronic components and not being time efficient in some applications because of its iterating process.

**Deflection Techniques:** The impedance estimation is done by measuring the voltage drop or the current through the load as a response to an alternative known current. This method is based on simple electronics using complex operations. Due to

this an application specific integrated circuit or microcontroller is needed to carry these operations.

Its main characteristic is the time efficient, being able to do short time accuracy measurements. For the impedance estimation we are going to focus only in the deflection techniques that are those that are commonly used in bioimpedance measurements.

In impedance estimation is it possible to do single frequency and multy-frequency analysis using different techniques, basing the study in the known excitation provided and the measured obtained. So for single frequency or sweep frequency measurements usually Sine Correlation is used and for multi-frequency measurements it is common used the Fourier Transform.

### **3.2. Analog Devices AD5933**

For the development of this work the Impedance Network Analyzer AD5933 has been chosen. The main advantage of this device is its capability to perform spectroscopy measurements of an impeditive load, both real and imaginary part with a small non expensive electronic board with reduced size.

AD5933 is an Integrated Circuit manufactured by Analog Devices. It is a 12-bit precision impedance converter which combines an on-board frequency generator with a 1 MSPS analog-to-digital converter and a Digital Signal Processor engine which performs a FFT-based impedance estimation.

It includes a serial I2C port as communication interface that allows the adjusting of several operation parameters as well as the transmission with an external Host of the impedance data results.

For the realization of this work is necessary knowing how some of the blocks of AD5933 works in order to the software implementation.

For detailed information about the AD5933 Network Impedance Analyzer, please read the datasheets of the AD5933 and its evaluation board.

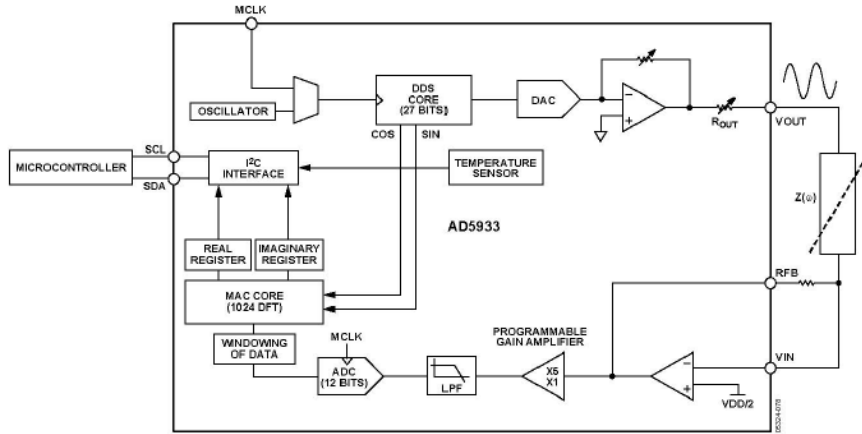

Fig 3.2 AD5933 block diagram

### 3.2.1 Voltage Generation and Excitation

The aim of this block is generating a sine waveform current from an external reference clock or by an internal oscillator. The AD5933 offers a frequency resolution programmable by the user. The frequency sweep is fully described by the selection of three parameters that allow performing a frequency sweep within the selected frequency range

- Start Frequency
- Frequency Increment
- Number of Increments

The AD5933 has a programmable gain stage in order to generate a programmable voltage output excitation, allowing the selection of four different output voltages. In this work the gain 1 is chosen providing an excitation of 1.98 V<sub>pp</sub> with the a DC Bias level of 1.48 V<sub>pp</sub>.

The work frequency range is between 1 and 100kHz with a 0.1Hz of frequency resolution that can be programmed by the application.

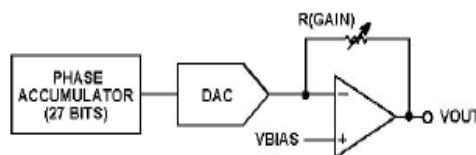

Fig 3.3 AD5933 excitation stage

### 3.2.2 Current Sensing Stage

The measure obtained. is the response to the excitation voltage through the impedance. The current is sensed at the sensing stage in order to estimate the impedance value through a Current-to-Voltage converter with a gain resistor called ‘feedback resistor’.

The signal is conditioned filtering and amplifying it and after it the digital samples coded in 12 bits are feed into a DSP core. This DSP performs a Discrete Fourier Transform on the sampled data and referenced sinusoidal signals from the DDS obtaining the Fourier Coefficients of both signals from wich impedance is estimated.

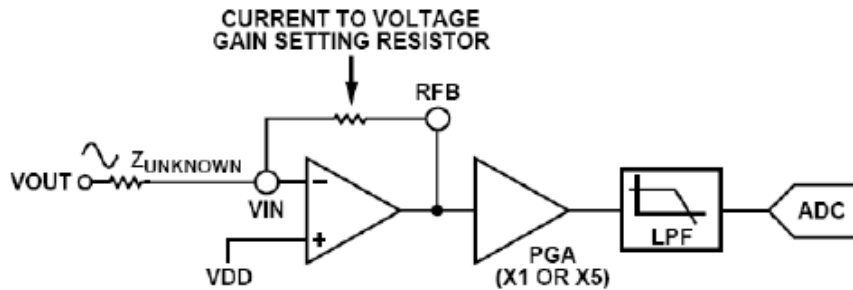

Fig. 3.4 AD5933 current sensing stage

### 3.2.3 Impedance Estimation

For the impedance estimation the AD5933 implements the Discrete Fourier Transform on DSP cover over the sampled current signal and the reference sinusoidal injecting signal. The DSP calculates a 1024 points DTF transform for each frequency point in the frequency sweep obtaining the real and imaginary components.

The impedance can be directly estimated by applying the Ohm’s law in the frequency domain:

$$\frac{1}{Z(w)} = \frac{V_{out}(w) - V_{in}(w)}{I_{load}(w)} \quad (3.2)$$

Where  $Z(w)$  is the impedance at the measured frequency,  $V_{out}$  and  $V_{in}$  are respectively the output and input voltage of the sensing stage and  $I_{load}$  is the current that flows through the impedance that we want to measure

As result the DFT provides with the Fourier Coefficients the relationship between the voltage signal controlling the excitation and the current signal through the load. From those coefficients the magnitude and the phase of the measure can be calculated from each frequency.

$$Magnitude = \sqrt{R^2 + I^2}$$

(3.3)

$$Phase = \text{Tan}^{-1}(I/R)$$

We can obtain the magnitude and the phase of the measured value with the following formulas where R is the resistance measured and I is the admittance measured

#### **3.2.4 Frequency Sweep**

The impedance spectroscopy measurement is done frequency by frequency. In the following diagram it is possible to see the operation flow of the source code for AD5933.

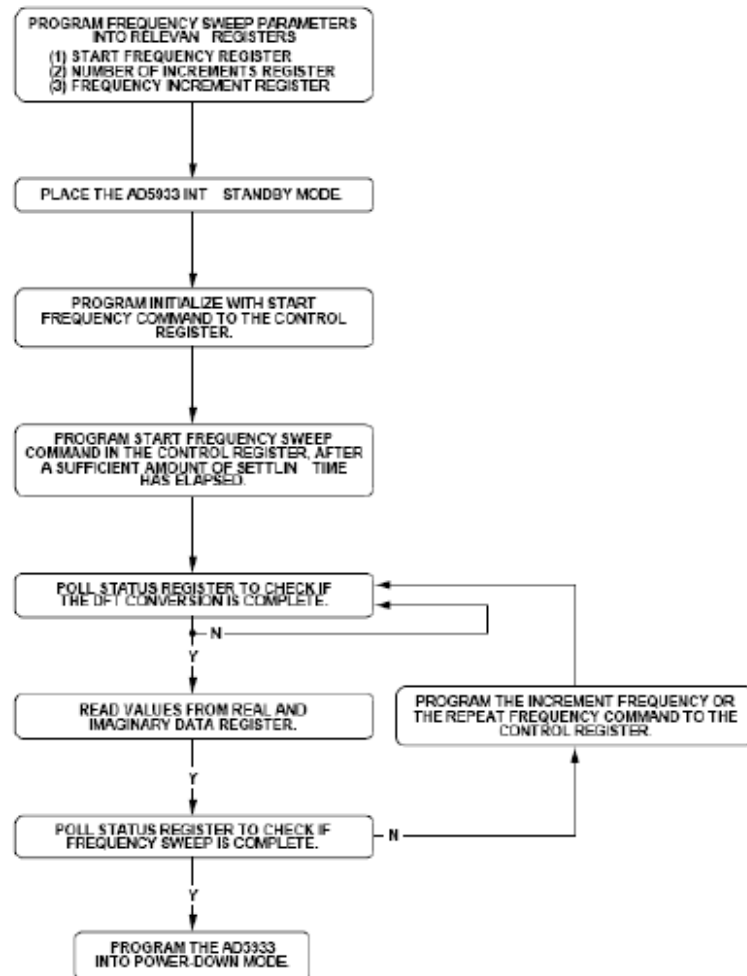

Fig 3.5 AD5933 frequency sweep flow chart

### 3.2.3 Calibration

It is important to notice that the voltage signal used as a reference enters into the DSP straight from the DDS while the exciting voltage applied on the load, and true responsible for the current following through the load is the signal at the output.

This process creates an error that it is necessary to solve in order to obtain a correct value of impedance that is done by the calibration. In the calibration a load with a known impedance value is placed between the exciting leads. Since the calibration load is known the calibration factor can be calculated to compensate the error occurred.

In this project the calibration is calculated at every single frequency point contained in a spectroscopy measurement. This way for known single frequencies we can know the appropriate gain factor.

$$G_{\text{Factor}} = \frac{\text{Admittance}}{\text{Magnitude}} \quad (3.3.3.a)$$

$$\text{Impedance} = \frac{1}{G_{\text{Factor}} \times \text{Magnitude}} \quad (3.3.3.b)$$

Where Gfactor is the gain factor applied to correct the measure.



### 3.3 Standardization in data storage: EDF+ files

In order to interpret unequivocally the data and measurements of the patients, it is necessary to store them following a certain standards, a standard that has to be known by the whole medical community. Therefore, the personal data of each patient, together with all the information related to the Bioimpedance measurement and the results obtained with it are stored in the user's machine under the EDF+ file format.

The European Data Format (EDF) is a simple and flexible format for exchange and storage of multichannel biological and physical signals. It was developed in Leiden in April 1990 by a few European 'medical' engineers who were working with sleep analysis algorithms. An extension of EDF, named EDF+, was developed in 2002 and is largely compatible to EDF. But EDF+ files can also contain interrupted recordings, annotations, stimuli and events. Therefore, EDF+ can store any medical recording such as EMG, Evoked potentials, ECG, as well as automatic and manual analysis results such as deltaplots, QRS parameters and sleep stages. The medical recording in our case is the Electrical Bioimpedance measurement.

The EDF+ file is stored in ASCII and has a header record, which is divided into two headers:

- The file header: it contains ten different fields with the version of the format, the patient identification, the recording identification, starttime of the recording, number of bytes in the header, and information about the data records. In our case, we just have one data record.

- The signal header: there is one for each of the signals in the data record. It also has ten fields with information about the type of transducer used, the physical dimension, the minimum and maximum values obtained in the measurement, the pre filter used and the number of samples in the data record.

The value of each signal obtained in the measurement is stored just after the last field of its corresponding signal header, in the field data record. All the fields of the EDF+ file headers, with their lengths, are explained in detail in the *figure3 .6*.

**FILE HEADER**

LENGTH	DESCRIPTION
8ascii	Version of this data format (0)
80 ascii	Local patient identification
80 ascii	Local recording identification
8 ascii	Startdate of recording (dd.mm.yy)
8 ascii	Starttime of recording (hh.mm.ss)
8 ascii	Number of bytes in header record
44 ascii	Reserved
8 ascii	Number of data records
8 ascii	Duration of a data record, in seconds
4 ascii	Number of signals (ns) in data record

**SIGNAL HEADER**

LENGTH	DESCRIPTION
ns*16 ascii	ns*label
ns*80 ascii	ns*transducer type
ns*8 ascii	ns*physical dimension
ns*8 ascii	ns*physical minimum
ns*8 ascii	ns*physical maximum
ns*8 ascii	ns*digital minimum
ns*8 ascii	ns*digital maximum
ns*80 ascii	ns*prefiltering
ns*8 ascii	ns*nr of samples in each data record
ns*32 ascii	ns*reserved

**Figure 3.6 Header record in a EDF+ file**

The vector BIA (Bioelectrical Impedance Analysis) is a vector analysis of direct impedance measurements  $R$  and  $X_c$  from one subject, together with the population statistics of sex, race, age and morphological parameters like Body Mass Index (BMI) weight and height of the patient, is clinically useful in monitoring body hydration in white adult populations of healthy subjects, renal patients with altered hydration or undergoing chronic haemodialysis, critical care patients, and obese subjects with stable or changing weight. In order to use the EDF+ files that our software application generates for all the purposes mentioned above, we have to add some information to the

file. The sex and the date of birthday have to be included in the Local patient identification field, as the EDF+ standard states. So we just need to add the height and race of the patient. We decide to use the field Reserved of the file header to store them.

As soon as an EDF+ file is created, it is encrypted. This process is done with security purposes, and will be explain in the next section. And just after it is encrypted, a new XML file is generated starting from the original EDF+ file. All EDF+ files have to be converted into XML files (even though the original EDF+ files are kept) in order to send them to the web server.



## ***CHAPTER 4***

---

### ***SOFTWARE APPLICATION***

#### **4.1 Introduction**

The software application implemented in this thesis work is based on the core of the software for evaluation board for the AD5933 circuit. We added new functionalities, as well as modified and deleted some existing ones, in order to adapt the code to the project specifications.

The original code had been written using Visual Basic 6.0, and we wanted to implement our software application in Visual Studio.NET. The reason was a matter of compatibility with new applications: new applications are not developed in Visual Basic 6.0 anymore, and we want our application to be compatible with any possible new application.

The instrumentation for the EBI measurement system is the hardware implemented by Ferreira & Sanchez with the supervision of the Dr. Fernando Seoane [7] that contains an Analog Front-End, which modifies the EBI measurement process of the AD5933 circuit. Such modification have been considered in the implementation of this software application

A full application for Bioimpedance measurement, record and monitoring has been developed.

## 4.2 Software application functions

The aim of this software application is to control and manage a monitoring system according to a standardized data format (EDF) that allows post-processing of the monitoring data.

### 4.3.1. Calibration

The calibration process is a mechanism applied on the impedance measurement process to compensate for systematic errors caused by the electronic components in the injection and measurement channels, i.e. time delays, attenuation, differences between the frequency response of the measurement channels, etc. It is necessary for the system to be calibrated to achieve a correct measurement. In the original software calibrating was always necessary before any measurement.

For developing a practical application it is an unnecessary invest time in calibration for every single measurement. Originally, each time that a measurement is done the system spent around 15 seconds in calibration before doing the actual measurement and also it is the user the responsible for the calibration process. This way, in the case that the user forgets to calibrate the measurements are erroneous. For avoiding this problem a new method of calibration has been implemented. The system allows two types of calibration.

#### 4.3.1.1. Automatic Calibration

If this type of calibration is chosen the system does not have to calculate the calibration matrix for compensating the errors. A calibration matrix is saved in disk for the whole frequency operation range of the AD5933 device. The calibration is done frequency to frequency so the application approximates the measurement frequencies to the calibration frequencies of the saved matrix creating a new calibration matrix that is used for calibrating the measured bioimpedance data.

Before creating this calibration method it was not sure that it was going to be suitable for the application, because as it is known the maximum calibration points that the AD5933 can calculate are 512. For creating the calibration matrix saved in disk the calibration points were calculated in the whole frequency spectrum (5-100 Khz) with

approximately an interval of 200Hz. Practical studies comparing point to point calibration shows that this method is appropriate and the error between point to point calibrated measurements and automatic calibrated measurements is almost null.

Each time the measurement scenario change it is recommended to perform a new calibration matrix should be calculated, otherwise the error introduced is significant.

#### **4.3.1.2. Point to Point Calibration**

For an accuracy measurement the system allows point to point calibration. In this case the calibration matrix is calculated for each measurement frequency points so the results obtained are more accurate.

In this case the calibration matrix is not saved and for this type of calibration the matrix should be calculated before each measurement.

#### **4.3.2. Single Measurements**

The system allows single measurements in a frequency range. The user selects three parameters that define the frequency points of the measurement (Start Frequency, End Frequency, Number of Increments) and the system gives back two matrix previous calibration.

A matrix with the resistance and another one with the reactance are given back to their further usage and analysis.

#### **4.3.3. Multi Measurements**

This application provides the possibility of doing various single measurements to the same patient according to a dead time and an interval. This is a useful tool for evaluating the change of the bioimpedance measurement along a time allowing the diagnosis of hydration dehydration or loss of body cell mass.

#### **4.3.4. Data Record**

The storing of the measured data was necessary. In this case a standardised recording of the data was needed. The system provides the possibility of storing the measured data, single measurements and multi measurements, according to a medical storing data standard (EDF), modified for bioimpedance applications.

#### 4.3.5 Patient Selection

This application was created with the idea of being a prototype of a medical measurement system that can be used in a hospital. So on we thought in the possibility of that various patients can use the application and the problem of implementing the patient header in the EDF format.

A data base with all the relevant information of the patient was created, allowing the selection of a patient previously saved in that data base or the creation of a new patient that immediately is added to the data base.

If before the measurement no new patient is selected the system will select the last patient that was chosen for the measurement also when the application is opened.

#### 4.3.6. Data Representation

For a first diagnosis of the data and the verification that the system works correctly, the representation of the measured data was necessary. This application allows different representations.

- Impedance module, Phase, Resistance or Reactance Vs Frequency
- Monitoring of a single parameter along the time

### 4.4. Bioimpedance Measurement Application

This application has been divided in different panels according to their functionality that allows the user in an easy and intuitive way to use the interface.

Fixed in the left side of the panel are the measurement parameters that have been chosen for the measurement and different buttons that allow the user to select the different options that provides the application.

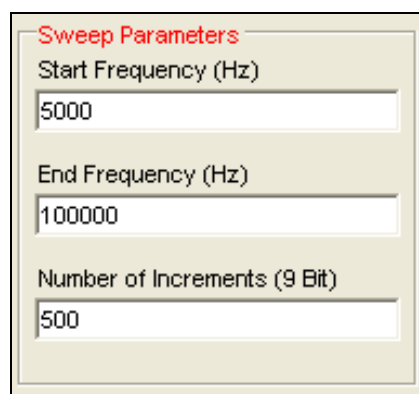

The image shows a dialog box titled "Sweep Parameters" with a red title bar. It contains three input fields with the following values:

Parameter	Value
Start Frequency (Hz)	5000
End Frequency (Hz)	100000
Number of Increments (9 Bit)	500

Fig 4.1. Frequency selection parameters.



Filling the three text boxes the frequencies of the measurement are selected selecting:

- Start Frequency: Selects the initial frequency in Hertz. According to the limitations of EBI measurement system. The minimum frequency is 5 kHz.
- End Frequency: Selects the final frequency in Hertz. According to the limitations of the EBI measurement system. The maximum frequency is 100 kHz.
- Number of Increments: Selects the number of samples. According to the limitations of the AD5933 the maximum number of samples is 512.

Once that the parameters have been selected clicking on the buttons or selecting the tabs it is possible for the user to move around the different options of the application. The default option chosen has been the sweep single panel to be considered the most used option.

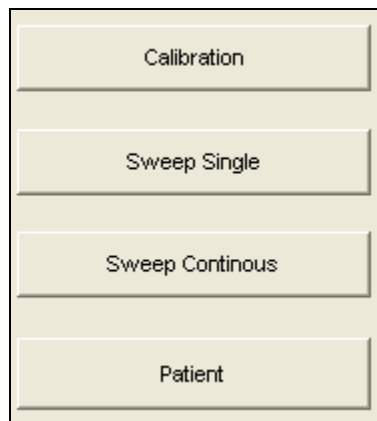
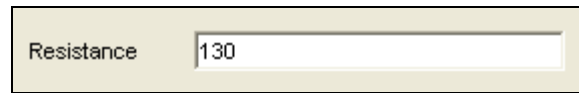

**Fig 4.2 Operation Selection Buttons**

#### **4.4.1 Calibration Panel**

When the user clicked on the 'Calibration' button or the 'Calibration' tab, the calibration panel is shown.

The resistance connected to the AD5933 device that allows the calibration can change, so the user has to put the calibration resistance value in its text box.



**Fig 4.3. Calibration Resistance Text Box**

When the program runs for the first time the saved calibration matrix for automatic calibration is loaded and shown in this panel and used as the default calibration matrix. The application allows the possibility of calculating a new calibration matrix if the conditions have changed or for point to point calibration.



**Fig 4.4. Calibration mode buttons**

If the 'Point to Point' button is clicked on the point to point calibration is calculated taken as default and shown in the panel

If the 'Recalculate' button is clicked on, the new calibration matrix for automatic calibration is calculated in the operation frequency range of the AD5933 and saved in disk. This matrix is taken as default and used for the calibration of the measured data.

If no button no calibration is done before the measurement, the system will take the calibration matrix that was previously saved in disk.

This panel also displays some of the values for the matrix selected as default calibration matrix. This way the user can check if the chosen calibration matrix is the appropriate or if the calibration procedure has been done successfully.

Frequency	Gain Factor Value	Phase Factor Value	Real Data	Imag. Data
5000	0,0276066034878564	92,8970386235005	-238	4703
5190	0,027567227926818	93,6839547400105	-303	4706
5380	0,0278442992977498	94,0777476928821	-332	4657
5570	0,0280415480940275	93,7598159377908	-304	4626
5760	0,0279512160381664	93,3527159960084	-272	4643
5950	0,0276689320073159	93,4287612440692	-281	4690
6140	0,0275660993116943	93,9029731005671	-321	4705
6330	0,0276440079785646	94,3659996324226	-358	4689
6520	0,0278163971962526	94,3563929084876	-355	4660
6710	0,0278714995237626	94,1556326785062	-338	4652
6900	0,0277325635965153	94,0368499906107	-330	4676
7090	0,0275894708734227	94,2476230241092	-349	4699
7280	0,0275405031960472	94,6174793160953	-380	4705
7470	0,0276022440801039	94,8353712562726	-397	4693
7660	0,0276832437972765	94,8740849124788	-399	4679
7850	0,0276304802181503	94,8647726170523	-399	4688
8040	0,0275713766700173	95,0129013935768	-412	4697
8230	0,0275556322967597	95,241709004005	-431	4698
8420	0,0275923921497405	95,4685798483041	-449	4690
8610	0,0276491225969595	95,5165846476036	-452	4680
8800	0,0276321373314103	95,5009502555932	-451	4683

Fig 4.5 Main parameters of the calibration matrix in use

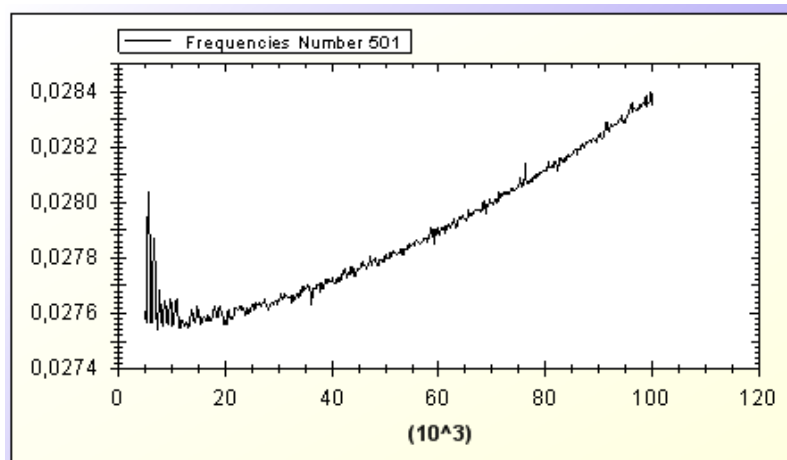

Fig 4.6 Impedance variation of the calibration matrix Vs Frequency

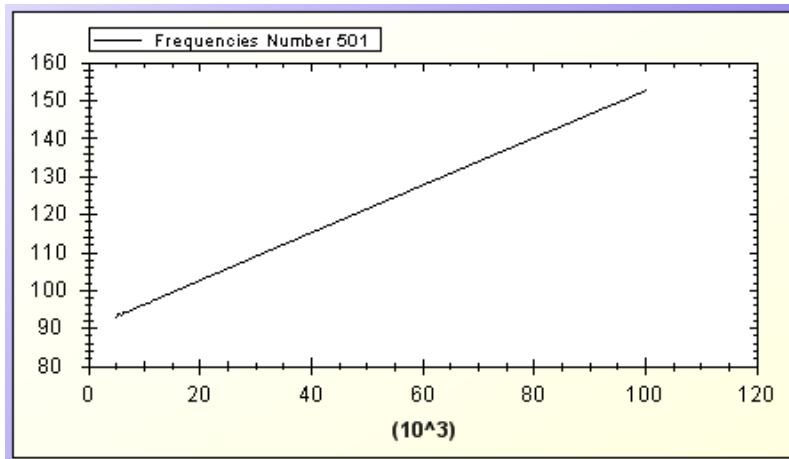

Fig 4.7 Phase variation of the calibration matrix Vs Frequency

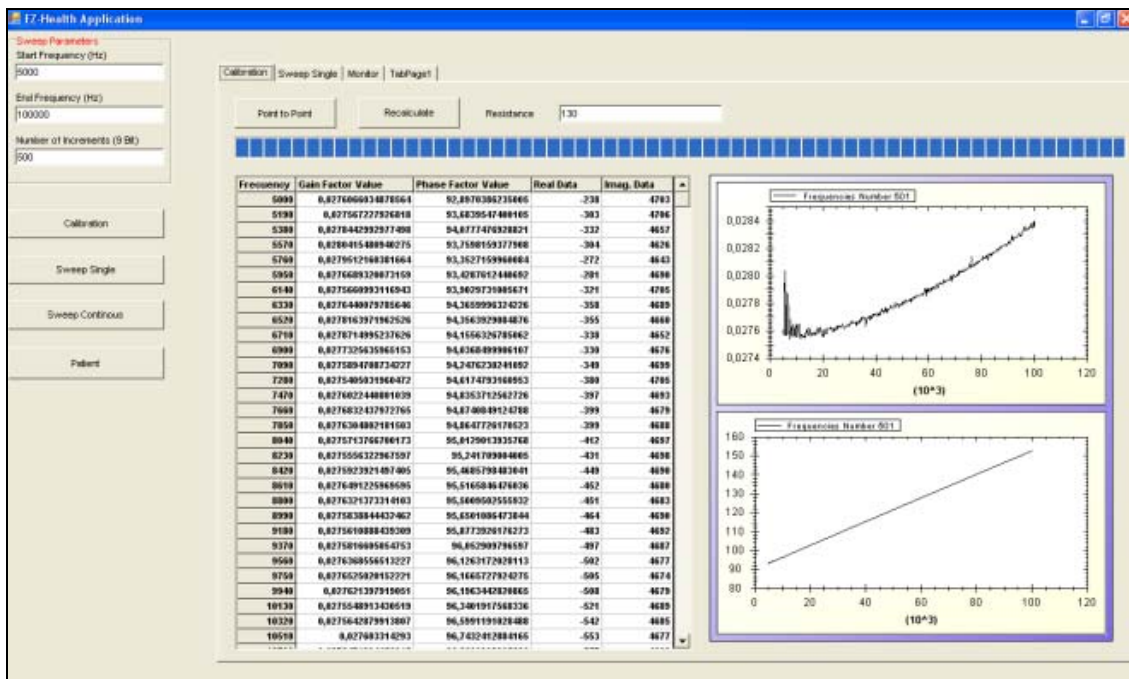

Fig 4.8. Full Calibration Panel

#### 4.4.2 Sweep Single Panel

When the 'Sweep Single' button or the 'Sweep single' tab is clicked on the panel is displayed.

This panel allows the user to initiates the bioimpedance measurement according to the frequency parameters selected.

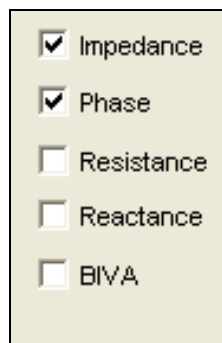

**Fig 4.9. Sweep Single selection Buttons**

When the ‘Sweep Button’ is clicked on, the EBI measurements start. While the measurement is being done, for avoiding any error derived of the communication between the board and the computer, the application is blocked not allowing any user activity.

It is important to explain that the first time that the system measures, the results obtained are erroneous, so it is necessary the creation of a bug function, that realizes a quick measured and after it the data measurement.

The measured data is displayed in the graphic below according to the option selected. It is possible to display different options in the same graph frame.



**Fig 4.10 Display selection buttons**

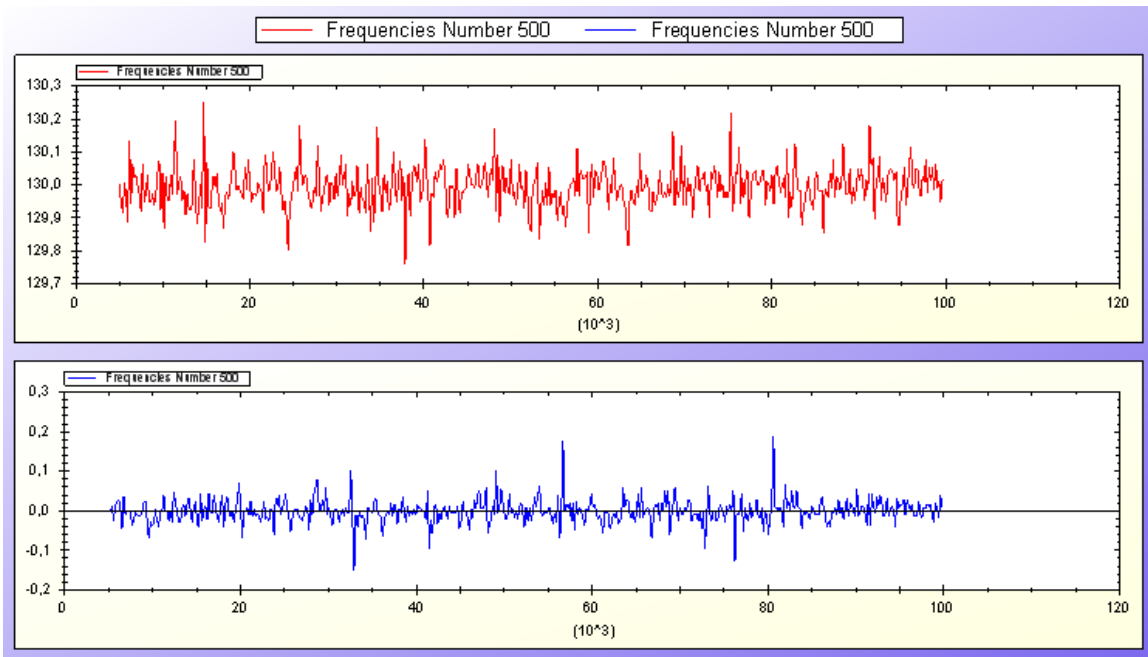

Fig 4.10 Display of impedance and phase versus frequency

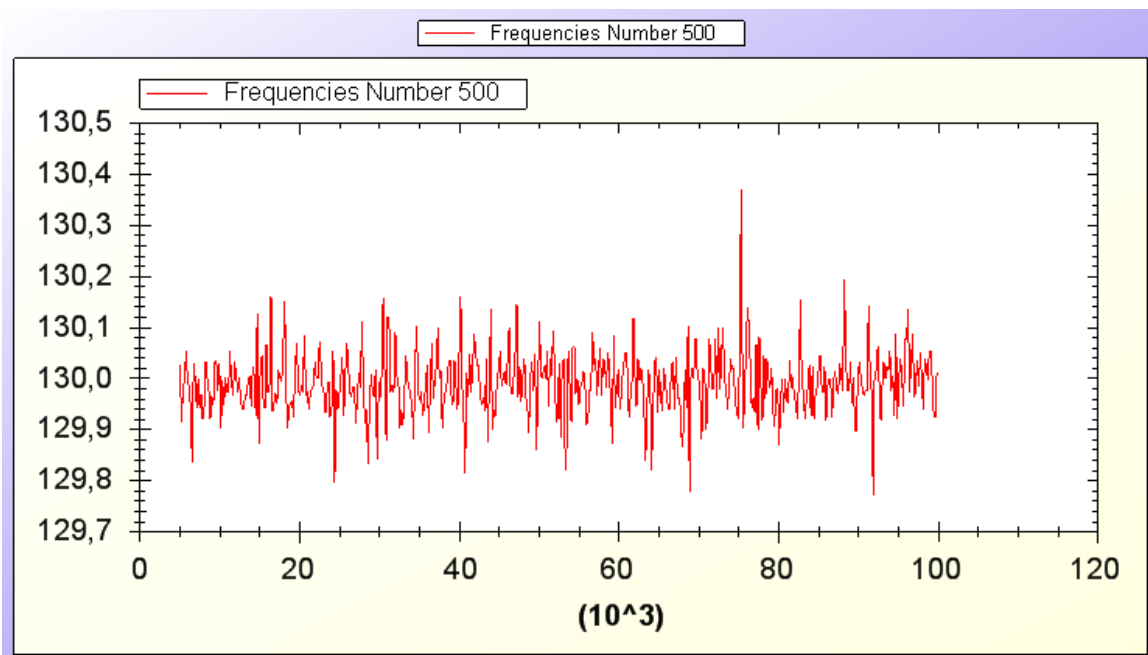

Fig 4.11. Display of impedance Vs frequency

Some statistics of the measurement are shown such as the mean, the maximum and the average value of the parameters of the measurement, impedance, phase, resistance, and reactance.

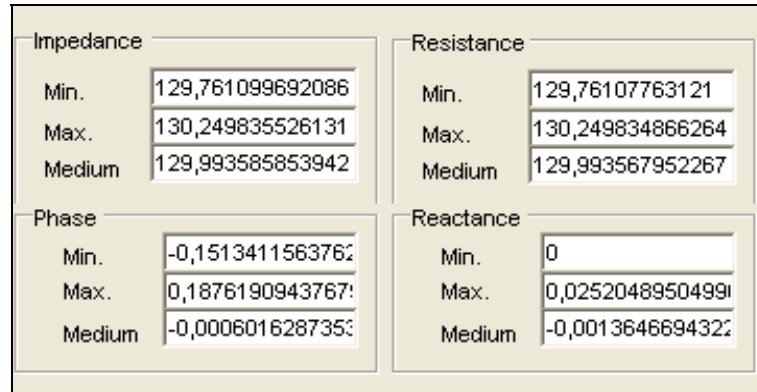

Fig 4.12. Measurement statistics

Also the possibility of recovering the value at a specific frequency is available. Filling the text box 'Search Frequency' and clicking on the button 'Search' the application displays the impedance measurement at the most likelihood frequency respect to the frequency included.

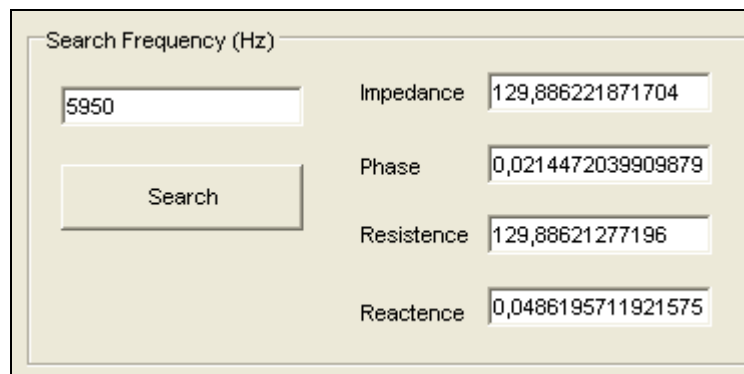

Fig 4.13. Measurement of bioimpedance parameters at a single frequency

The measurement can be saved in EDF format clicking on the button 'Save Sweep Single' appearing a command dialog that allows the user the selection of the name and the location of the data file.

In the same way the currently displayed graph can be saved clicking on the button 'Save Graph'.

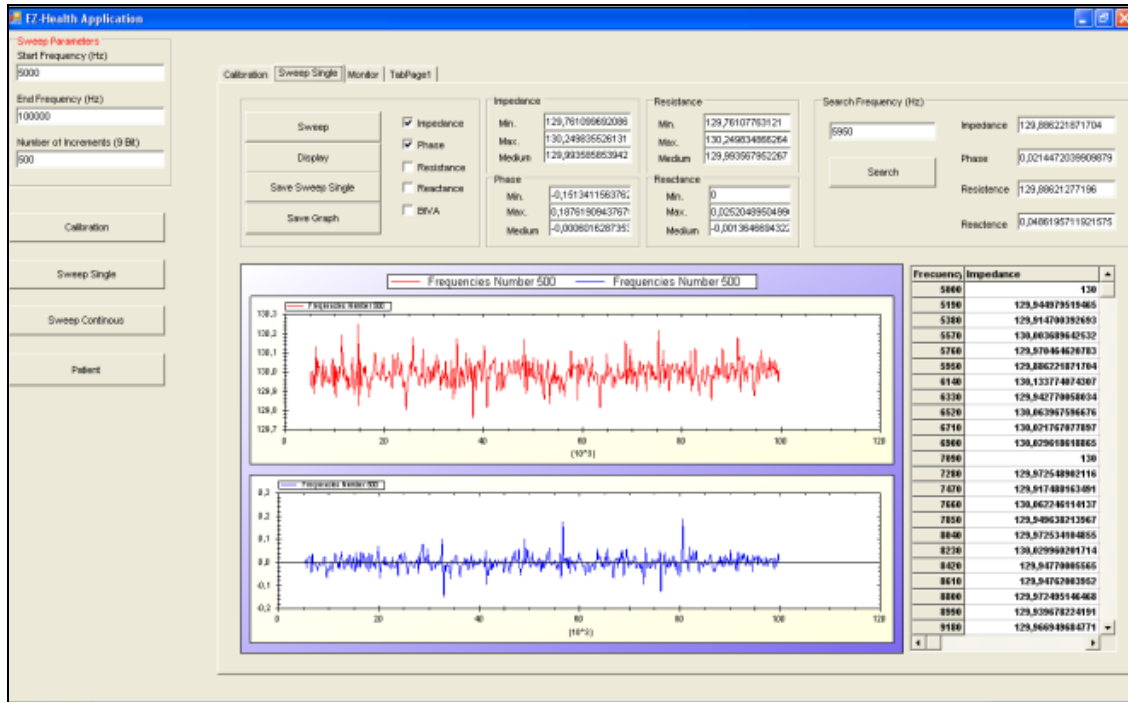

Fig 4.14 Full sweep single panel

#### 4.4.3 Sweep Continuous Panel

When the 'Sweep Continuous' button or the 'Sweep Monitor' tab is clicked on the panel is displayed.

This panel allows the possibility of various single multifrequency measurements, during a specific time defined by 'Measure time' and 'Sampling Interval' both selected by the user. When the button 'Start' is clicked on the measure process starts until the dead time except if 'Stop' button is clicked on that also stops the process. Also when Start button is clicked on a command dialog is open to allow the user to save the data according to EDF format.

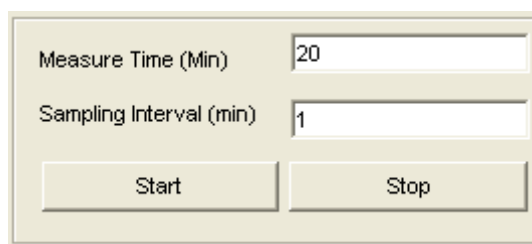

Fig 4.15 Multi measurement time selection



The measurements done can be displayed in the graph below. In this case is not for a diagnosis, because the whole measurements should be analysed together. The aim of this representation is monitoring, checking that the process is working correctly and there is no problem with the electrodes or the system.

There are several ways of display the monitoring EBI data.

- If 'Impedance' is checked the graph shows the impedance of the last measurement versus the frequency
- If 'Phase' is checked the graph shows the phase of the last measurement versus the frequency
- If 'Resistance' is checked the graph shows the reactance of the last measurement versus the frequency
- If 'Reactance' is checked the graph shows the resistance of the last measurement versus the frequency
- If 'Single Impedance' is checked the graph shows the impedances of the measurements along the time at the frequency written by the user in the 'Frequency' text box.
- If 'Single Phase' is checked the graph shows phases of the measurements along the time at the frequency written by the user in the 'Frequency' text box.
- If 'Single Resistance' is checked the graph shows the resistances of the measurements along the time at the frequency written by the user in the 'Frequency' text box.
- If 'Single Reactance' is checked the graph shows the reactance of the measurements along the time at the frequency written by the user in the 'Frequency' text box.

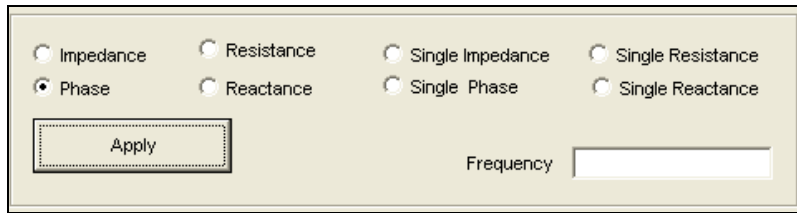

Fig 4.16 Multi measurement display options

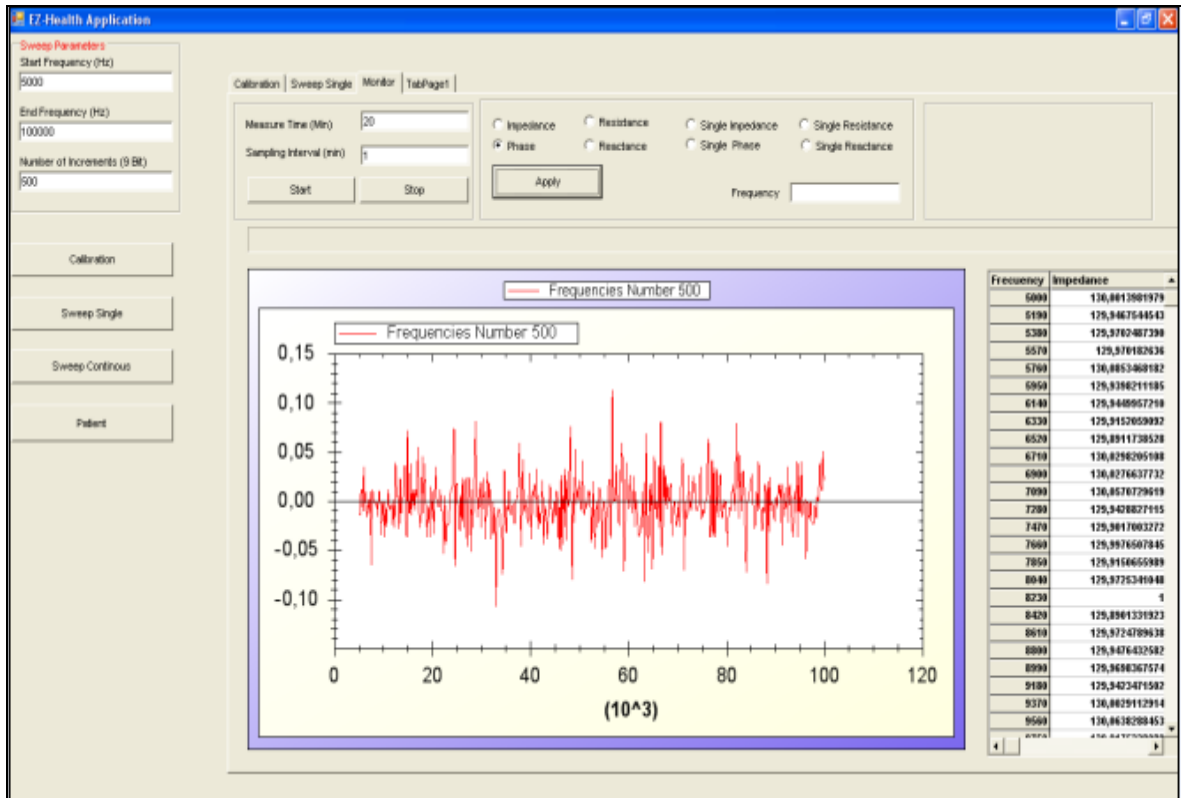

Fig 4.17. Sweep Continuous Full panel

#### 4.4.4 Patient Panel

When the 'Patient' button or the 'Patient' tab is clicked on the panel is displayed.

For a multi patient application it is necessary the possibility of choosing between different patients saved in our patients data base or creating a new panel to be added in this data base.

All the patients contained in the data base are showed in the list box, allowing the possibility of choosing one of them clicking on the button 'Load Patient'.

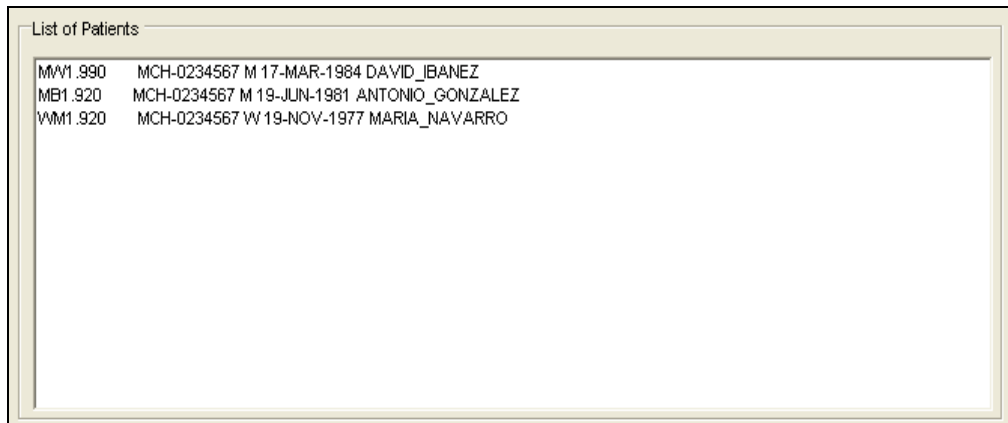

The screenshot shows a window titled "List of Patients" with a list of three patient records. Each record consists of a patient ID, a medical ID, gender, birth date, and name.

Patient ID	Medical ID	Gender	Birth Date	Name
MM1.990	MCH-0234567	M	17-MAR-1984	DAVID_IBANEZ
MB1.920	MCH-0234567	M	19-JUN-1981	ANTONIO_GONZALEZ
WM1.920	MCH-0234567	W	19-NOV-1977	MARIA_NAVARRO

**Fig 4.18 Patient list**

New patients can be added filling the following formulary. When the button 'Add Patient' is clicked on the new patient is saved in the data base and shown in the list of patients. This patient is not selected for the measurement, for choosing him we have to select him in the list box and press the button 'Load Patient'.

If the button 'Clear' is clicked on all the text boxes are erased allowing an easy addition of a new patient

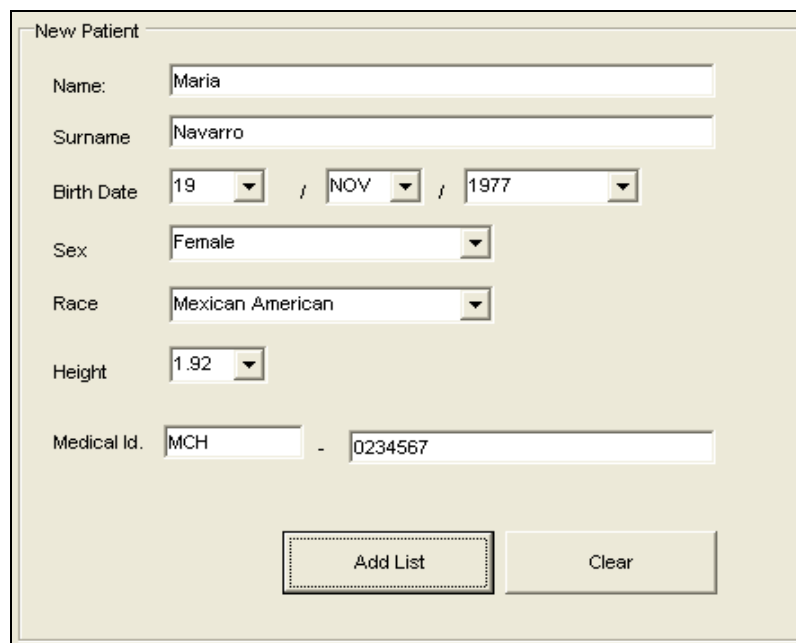

The screenshot shows a "New Patient" form with the following fields and values:

- Name: Maria
- Surname: Navarro
- Birth Date: 19 / NOV / 1977
- Sex: Female
- Race: Mexican American
- Height: 1.92
- Medical Id.: MCH - 0234567

At the bottom of the form are two buttons: "Add List" and "Clear".

**Fig 4.19 New patient's formulary**

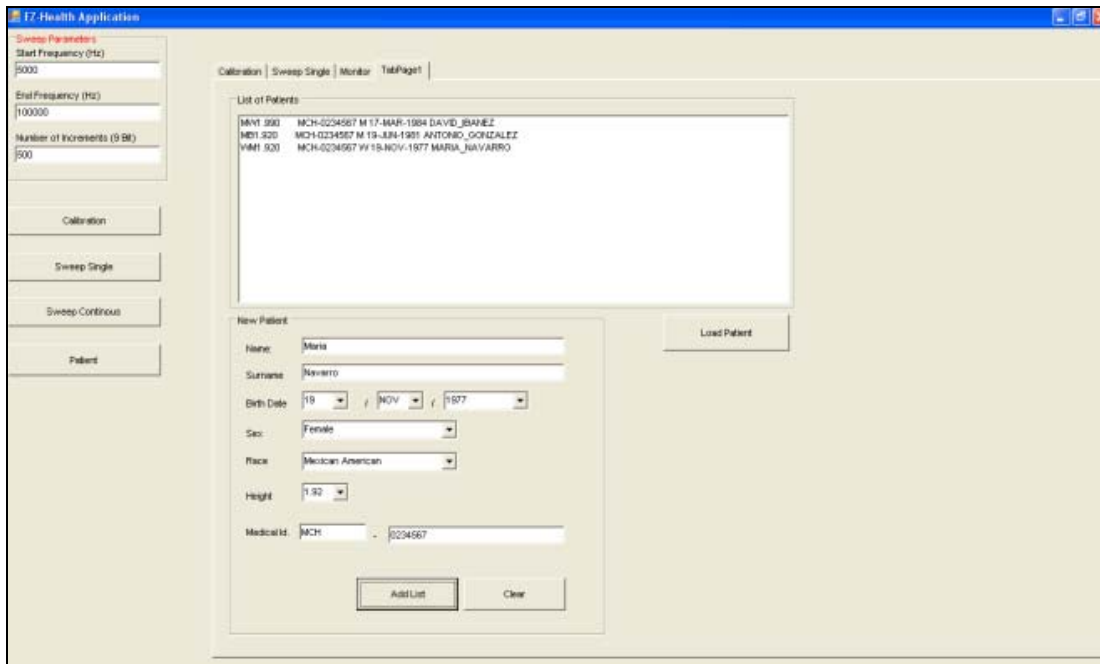

Fig 4.20 Full patient selection panel

## **CHAPTER 5**

---

### **BIOIMPEDANCE VECTOR ANALYSIS**

#### **5.1. Bases of BIVA**

In Piccoli et al (1994) new method for monitoring body fluid variation and body analysis was developed. This is a non-invasive assessment of hydration that can be performed by the evaluation of the bioelectrical impedance of the human body.

In contrast to other bioimpedance methods this approach does not yield any absolute estimate of ECW, ICW or TBW, makes no assumptions about body geometry, hydration state, or the electrical model of cell membranes and is unaffected by regression adjustments [3]. Without the need of an electric circuit model to represent and interpret the measurement results,  $Z$  can be considered as a bivariate random vector, with the same properties as either real or complex vector. The attractiveness of BIA lies in its potential as a stand alone procedure free from anthropometry [3].

##### **5.1.1. BIVA Statistics**

This method is based in the analysis of the bivariate distribution of the impedance in a healthy population. This method considers the reactance ( $R$ ) and the admittance ( $X_c$ ) as members of the impedance vector ( $Z$ ). This analysis is divided in several study groups because of the dependence of the impedance with gender and race. Both components are standardized by the height ( $R/H$ ,  $X_c/H$ ) and can be represented in polar axes.

When the values are plotted we can see that they follow a Bivariate Gaussian Distribution that can be defined by two values, the mean and the standard deviation. Correlation between these two variables determinate the ellipsoidal shape that is called  $RX_c$  Graph.

The graph represents elliptical probability regions in the R/H-Xc/H plane with curves or surfaces showing the values of a probability function for the joint distribution of R/H and Xc/H values. We could plot in this graph the confidence ellipses for mean vectors and tolerance ellipses for individual vectors [2].

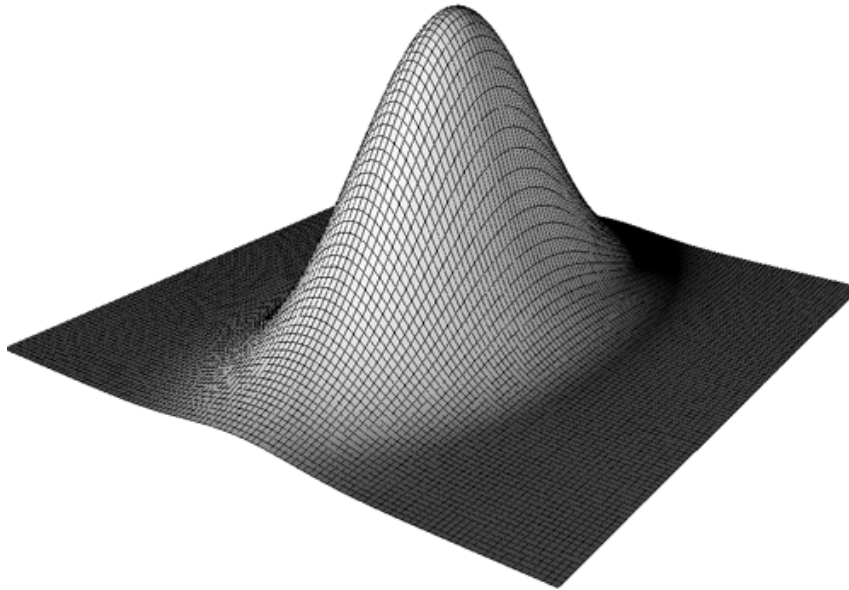

**Fig .5.1 Gaussian Distribution**

The graph represents elliptical probability regions in the R/H-Xc/H plane with curves or surfaces showing the values of a probability function for the joint distribution of R/H and Xc/H values. We could plot in this graph the confidence ellipses for mean vectors and tolerance ellipses for individual vectors [2].

### **5.1.2. RXc Graph**

This method is based in the analysis of the bivariate distribution of the impedance in a healthy population. This method considers the reactance (R) and the admittance (Xc) as members of the impedance vector (Z). This analysis is divided in several study groups because of the dependence of the impedance with gender and race. Both components are standardized by the height (R/H, Xc/H) and can be represented in polar axes

This distribution is done about healthy population and in this three reference percentiles or tolerance ellipses were taken. The percentiles were calculated at 50%, 75% and 95%. indicating on the graph the probability that an individual vector falls at a given distance from an observed mean vector of a reference population [1]. By plotting the two components R/H and Xc/H measured in an individual subject as an individual impedance vector (a point) on the RXc graph, one can directly rank its distance from the reference mean vector through the tolerance ellipses (RXc point graph) [3].

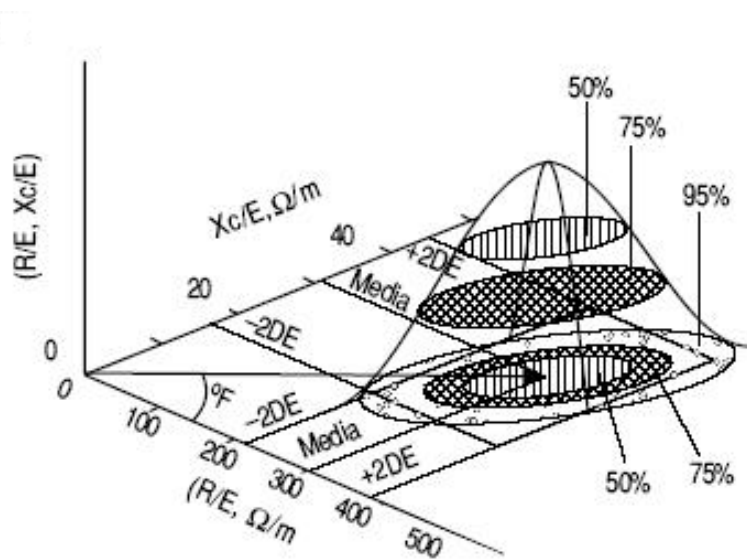

Fig 5.2 Percentiles in the case of the distribution of Men Mexican American [6]

### 5.1.2. RXc Score Graph

The RXc-Score Graph allows the evaluation of an individual impedance measurement with respect to a reference healthy representative population according to gender and race [1]. Now with this kind of representation is not necessary a graph for each referenced population, only the transformation of the original bivariate impedance measurements into bivariate Z scores. The RXc-Score Graph is a good approximation where the measured values can be represented in a single graph for all the referenced populations.

Z scores are pure numbers that are calculated for each subject as the deviation of R and Xc from their mean and divided by their Standard Deviation. Each Z score is

referenced to its specific population according to the sex and race. The formulas used to calculate the Z scores are:

$$Z(R) = \frac{R_{Measured} / H - R_{Mean} / H}{SD(R)} \quad (5.1)$$

$$Z(Xc) = \frac{Xc_{Measured} / H - Xc_{Mean} / H}{SD(Xc)} \quad (5.2)$$

By plotting the two mean components R/H and Xc/H measured in a group of subjects as a mean impedance vector with its 95% confidence ellipse, one can directly establish the mean vector position and variability in the corresponding population [3].

### 5.1.3 BIVA Interpretation

The vectorial representation offers us the option of examining a subject regarding to two variables R and Xc simultaneously. As it is explained before the resistance and the admittance show the body water and the cell mass behaviour respect. This is a powerful tool that makes no assumption of the electrical cell structure and the study is independent of the body weight or the body fat as previous methods did.

The Bioimpedance Vectorgraph allow the comparison of a patient measurement with reference values from a healthy specific population related to the patient by mean of the tolerance ellipses that state the probability that an individual measurement will be located at a certain distance from the mean vector of the referenced population. It allows separate assessments of a pathological change in bodily composition by comparing a measure result with this referenced tolerance ellipses [3].



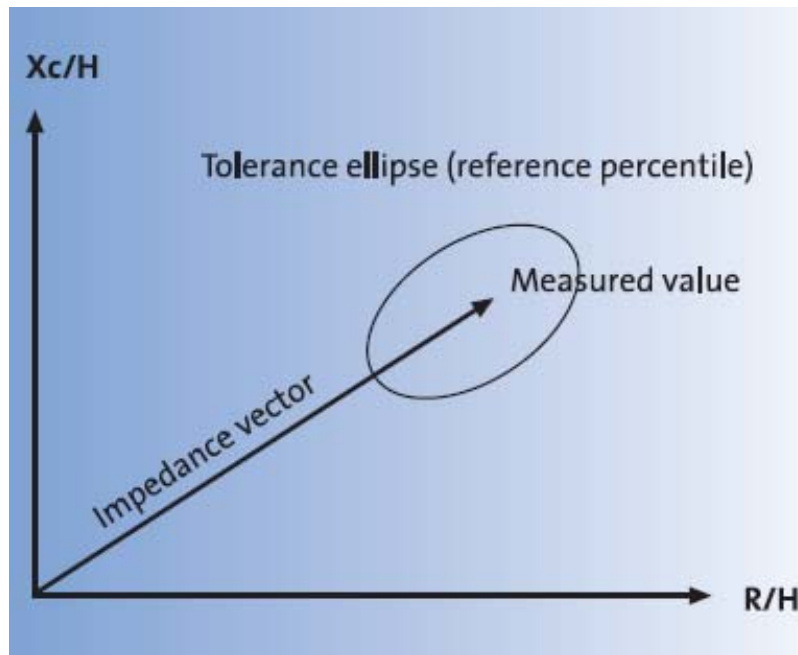

Fig 5.3 Bioimpedance Vector Graph

Liquid shifts are imaged along the long axis of the tolerance ellipses, with the top and bottom poles of the ellipse of the 75% tolerance interval specifying the biological limit values for clinically relevant dehydration and hyperhydration accordingly [2]. Variations of the hydration without alterations in tissues structure are associated to stretches of the impedance vector along the long axis of the tolerance ellipses [1]

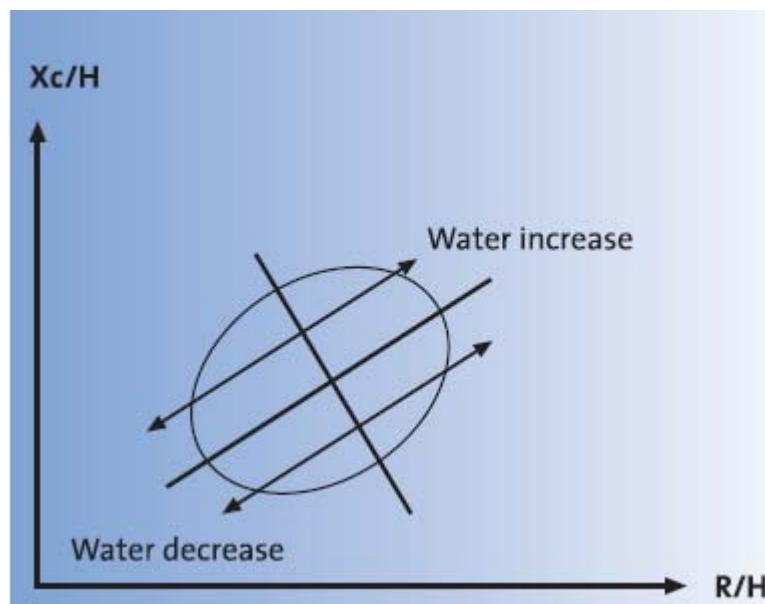
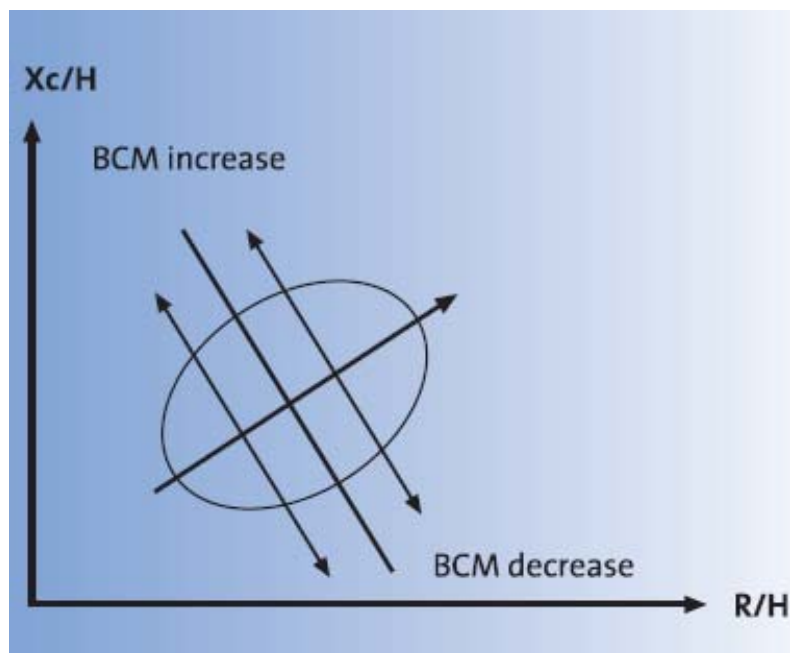

Fig 5.4 Displacement of the impedance vector according to the water amount

The direction of the vector (angle vector to the abscissa, or phase angle) is determined by the body cell mass. In the event of a pathological lost of BCM (cachexia), the BCM drops, and with it the  $X_c$ /Height vector components as well [BIA compendium]. Variations of the amount of soft tissues are associated with a movement of the impedance vector in the short axis direction. The phase angle can suffer a progressive increment in the case of obese people and athletes or a progressive reduction in the case of malnutrition or anorexia [1].



**Fig 5.4 Displacement of the impedance vector according to the BCM amount.**

Combined variations of the hydration and tissues structure are associated with the migration of the vector along the two axes. These assumptions let the BIA Vectorgraph several diagnosis advantages.

BIVA enables a patient's liquid status or body cell mass to be assessed using a comparison with population-specific reference values.

BIVA enables their measurements results to be evaluated solely on the basis of the raw impedance date, the resistances  $R$  and  $X_c$  independently of the assumptions on which the algorithms for calculating bodily composition are based [3].

Allows the evaluation of the impedance measurement by means of the BIVA result in a quality check, which prevents both a faulty measurement and a misinterpretation of the results in terms of a faulty prediction of bodily composition. By comparing an individual measured value with the tolerance ellipses of the reference population, vectors can be identified that lie outside the normal range. Vectors that exceed the 75% tolerance interval can be used only for predicting the bodily composition with an increased probability of error. Vectors located outside the 95% tolerance interval must not be used for calculating the TBW, FFM and FM since either an incorrect electrode placement or a pathological hydration (oedema or dehydration) is involved [3].

BIVA facilitates monitoring of a patient's liquid status during the course of the therapy. Assessing the water balance is a particular challenge in the case of critically ill patients. Here the customary BIA formulas for calculating the compartments can be used only with restrictions. BIVA by contrast, utilises only the original electrical measured values, and will provide reliable results even in the event of divergent hydration of the body [3].

## **5.2 BIVA Implementation**

### **5.2.1 Data Used**

The data used for the realization of this study belongs to the studies of Antonio Piccoli (Impedance Vector Distribution by sex, race, body mass index and age in the United States: Standard reference intervals as bivariate Z scores) [1].

In this study the data were collected from a nationally representative sample of US civilian non-institutionalized population. The subjects were classified in for ethnic groups: non-Hispanic White, White, non-Hispanic Black and Mexican American and according to their gender. 39.695 people were selected for the measurement and 30.818 of them were medical examined. Several aspects were measured including weight, height, lengths, skinfolds, circumferences, breaths and whole-body impedance (R and Xc components).

The BIVA measurements were adopted by procedures in NHANES III [6]. A 700 uA amplitude signal at 50 KHz frequency were applied. R and Xc values were recorded

from subjects lying on supine non-conductive examination table without pillows under their heads and the use of standard, termopolar placement of disposable foil-gum skin electrodes on the wrist-hand and the ankle foot [1].

Using statistical methods univariate and bivariate statistical measures such as mean, standard deviation (SD), and simple correlation coefficient [ $r$ ] were calculated obtaining the results shown in table I.

**TABLE I IMPEDANCE VECTOR COMPONENTS FOR THE REFERENCED POPULATION**

	R/H( $\Omega/m$ )		R/H( $\Omega/m$ )		R
	M	SD	M	SD	
Non-Hispanic White					
Men n=1572	277.2	33.6	38.1	6.2	0.60
Women n=1625	372.9	44.0	46.9	7.1	0.61
Non-Hispanic Black					
Men n=1254	282.9	37.3	41.4	7.0	0.63
Women n=1099	372.5	45.8	50.6	8.2	0.69
Mexican American					
Men n=1400	293.1	36.3	42.2	6.7	0.62
Women n=1072	390.6	45.8	51.1	8.0	0.65

### 5.2.2 Implementing the Ellipses

In this case of bivariate normal distribution tolerance intervals can be calculated by exact methods according to [7].

The sum of the squares of  $N$  independent, *Gaussian* random variable (with zero mean and unit variance) will follow a continuous Chi-square distribution with " $N-1$ ",  $F$  distribution relates the ratio of chi-square variates. Chi-square has statistical use in testing whether or not the sampling methodology produces *Gaussian* results. The cumulative distribution functions returns the probability that an observed chi-square

statistic will be less than "chs" with "dof" degrees-of-freedom. Low values indicate "cooked" or "biased" sampling; there are insufficient outliers. High values indicate significant differences between model predictions and experimental outcomes.

As a statistical test, the F Snedecor's ratio checks the assumption that the variance of two populations is the same. Returns the probability that an observed F-ratio will be less than "f" with "dof1" and "dof2" degrees of freedom. Low and high values indicate significant differences between two sample variances.

For implementing the tolerance ellipses we have n pairs of observation x and y, that follow a Gaussian distribution with standard deviations  $S_x$  and  $S_y$  and a correlation coefficient  $r$ . For a fixed  $\alpha$  probability level, we take the Snedecor's F value with w and n-2 degrees of freedom [1] In our case for 50%, 75% and 95% tolerance ellipses the values of  $\alpha$  are 0.5, 0.25 and 0.95 respectively.

RXc graphs can be calculated using the equations [1], where L is the longitude of the semi-axis of the ellipse and b are the slopes:

$$L_1, L_2 = \sqrt{K} \cdot \sqrt{(n-1)(S_x^2 + S_y^2) \pm \sqrt{[(n-1)(S_x^2 + S_y^2)]^2 - 4(n-1)^2(1-r^2)S_x^2S_y^2}} \quad (5.3)$$

$$b_1, b_2 = (S_x^2 - S_y^2) / 2rS_xS_y \pm \sqrt{1 + [(S_x^2 - S_y^2) / 2rS_xS_y]^2} \quad (5.4)$$

RXc-Score graph can be calculated using the equations [1], where L is the longitude of the semi-axis of the ellipse and b are the slopes:

$$L_1, L_2 = \sqrt{K} \cdot \sqrt{2(n-1) \pm 2r(n-1)} \quad (5.5)$$

$$b_1, b_2 = \pm 1 \quad (5.6)$$

In both cases K factor can be calculated as the following way

$$K = F(n-1) / n(n-2) \quad (5.7)$$



## **CHAPTER 6**

---

### ***MATLAB BASED BIVA***

#### **6.1. Matlab Based BIVA**

As we have seen before a new tool for the measurement, recording and monitoring of Bioimpedance has been developed. Such application lacks any functionality regarding data analysis and consequently in order to obtain a complete EBI system it is necessary the implementation of an application data analysis and measurement interpretation.

The existing software available for BIVA (Free software is available from Antonio Piccoli [apiccoli@unipd.it](mailto:apiccoli@unipd.it)) is based in a Microsoft Excel interface based on several Visual Basic functions used as Macros. It is our opinion that this application lacks certain analysis functionalities time analysis plus it does not allow scalability, therefore it was decide to build an application with an increased scalability and usability.

Matlab is a is a numerical computing environment and programming language that allows among other things easy matrix manipulation plotting of functions and data, implementation of algorithms, creation of user interfaces, and interfacing with programs in other languages.

Because of all these features Matlab has been chosen as the environment for developing the new application

The aim of this part of the thesis is developing a Matlab based application compatible with the Bioimpedance measurement software created and with EDF+ format that allows BIVA. Simplicity for the user, maybe without any knowledge of Matlab, has been considered when designing the application.

## 6.2 Evaluation BIVA Panel

This interface allows the creation of a application similar to the BIVA software developed by Piccoli. In this case the data are introduced by the user who has to choose between the different options for a correct plotting of the introduced data.

This is a useful tool for researching, evaluating data that have not been acquired by our system or is not in EDF+ format. This way with this tool it is possible to evaluate data corresponding to different studies, plotting the samples in the BIVA graphs.

The user should select the gender before the analysis in the correspondent popup menu.

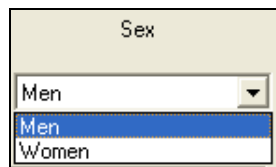

**Fig 6.1 Sex selection popup menu**

Three different races can be evaluated according to [1]. Non Hispanic White, Non Hispanic Black and Mexican American., that have to be also selected by the user.

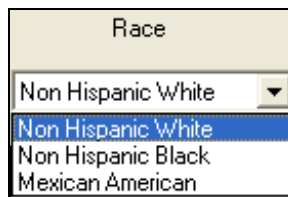

**Fig 6.2. Race selection popup menu**

The application allows the representation of the RXc Score Graph and the RXc Graph with its different ellipses depending on the sex and race

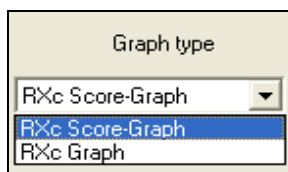

**Fig 6.3. Graph type selection popup menu**



Once the user has selected all the parameters, it is time to set the values of the resistance and the reactance normalized by the height,  $R/H$  and  $X_c/H$  respectively, in the text boxes. Clicking on the button plot displays the vector point in the convenient graph. We have also the option of deleting the previous plotted points with the button clear.

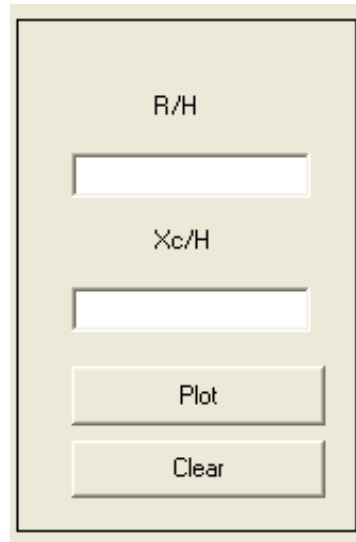

**Fig 6.4 Selection values box**

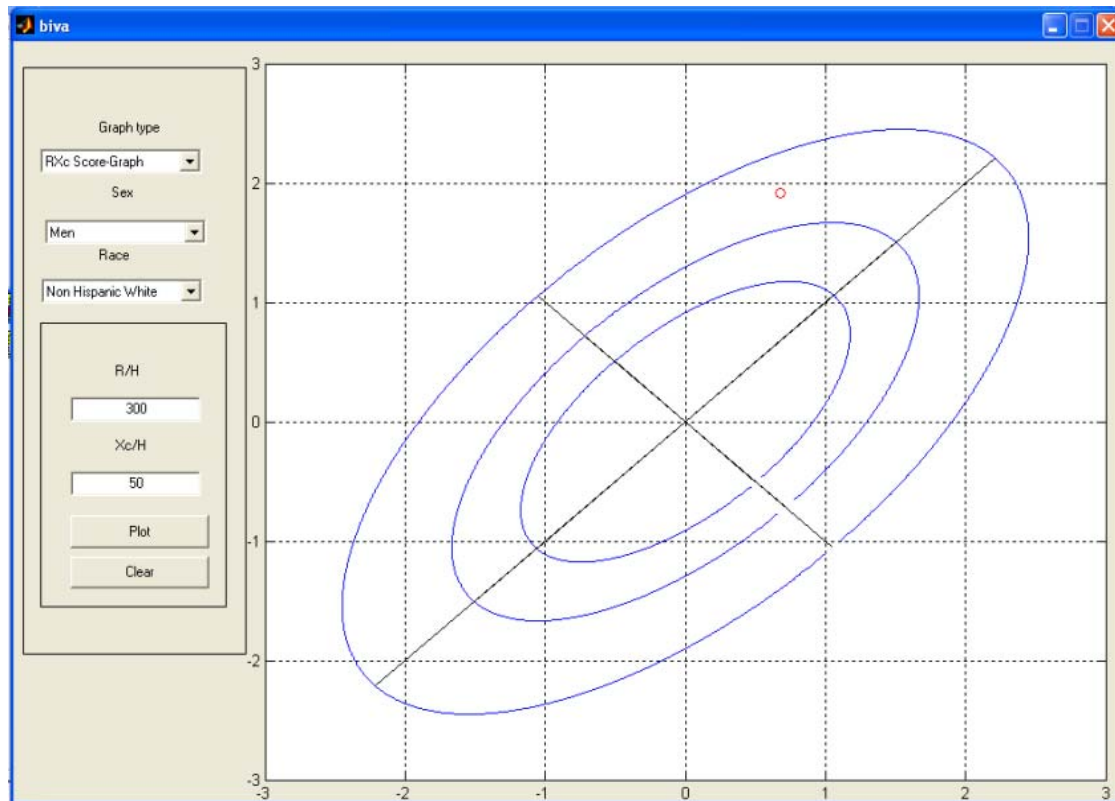
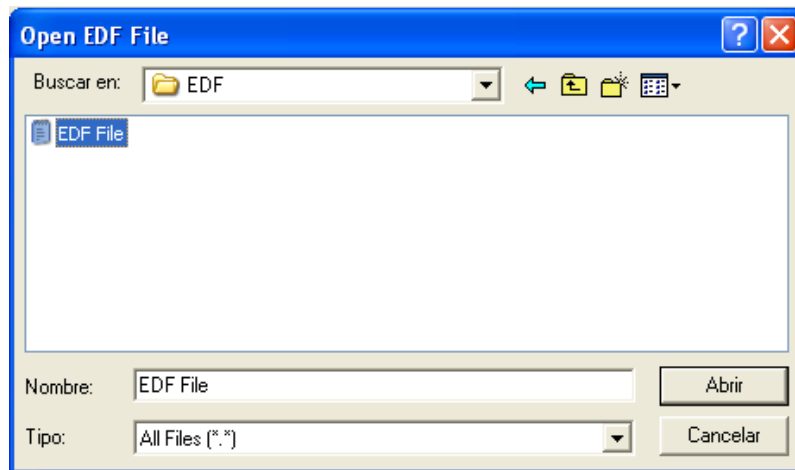

**Fig 6.5. Evaluation BIVA application**

### **6.3 BIVA EDF APPLICATION**

For analysing the data recorded with the EBI measurement application a BIVA EDF software was developed. The aim of this application is opening any Bioimpedance data recorded in the EDF format explained before allowing the BIVA for single frequencies and also the monitoring along the different records of a single measurement as well as time analysis.

When the application starts the user should select the data for its subsequent analysis. This is done pressing the button 'Open EDF'. When this button is clicked a command dialog is open allowing the user to browse for the file. In this case as it is known that EDF+ format is a char data saved file, so it may have different extensions, '.txt', '.edf', etc, that is why any kind of file can be opened.



**Fig.6.6 Open EDF command dialog**

Once that the file is opened some information about the patient is showed in order to understand know more about the patient that is being analysed. This information belongs to two types: personal information such as the name of the patient and birth date and useful information for understanding the obtained results and morphological like the Height, the gender and the race and the measurement day, all of them recovered from the EDF file.

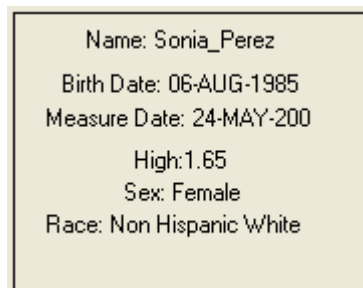

**Fig.6.6 Open EDF command dialog**

Once the data is loaded it is possible to check and select the frequencies of the measurement and the records displayed in two different list boxes for plotting the selected data. The application also allows the selection of the BIVA graph type, RXc Graph or RXc Score Graph by a pop up menu and even the frequency of the measurement.

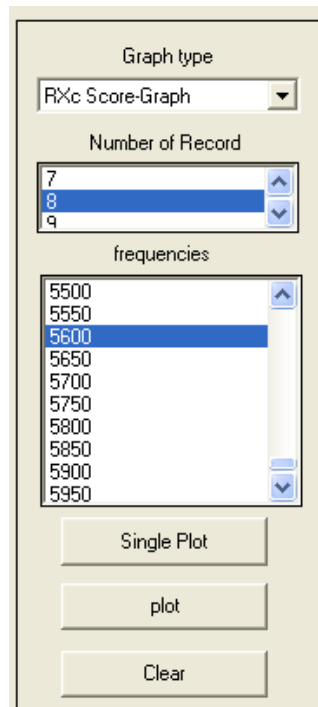

**Fig 6.7. Example of different records and frequencies in the plotting selection menu**

When the user selects the corresponding frequencies, record and graph type two types of plots are possible to create.

If the button ‘Single Plot’ is clicked the representation of single vector point at the selected record and frequency are represented in the chosen graph. This option is useful for the evaluation of a chosen EBI measurement at a single frequency and in a desired time.

If the button ‘Plot’ is clicked monitoring is available. All the records at the selected frequencies are represented allowing the study of the variation of the EBI measurement along the time.

In this application plotted data are kept in the graph to allow the comparison between the different measurements. It is also possible deleting the plotted data clicking on the button ‘Clear’ that deletes all the EBI vectors previously represented.

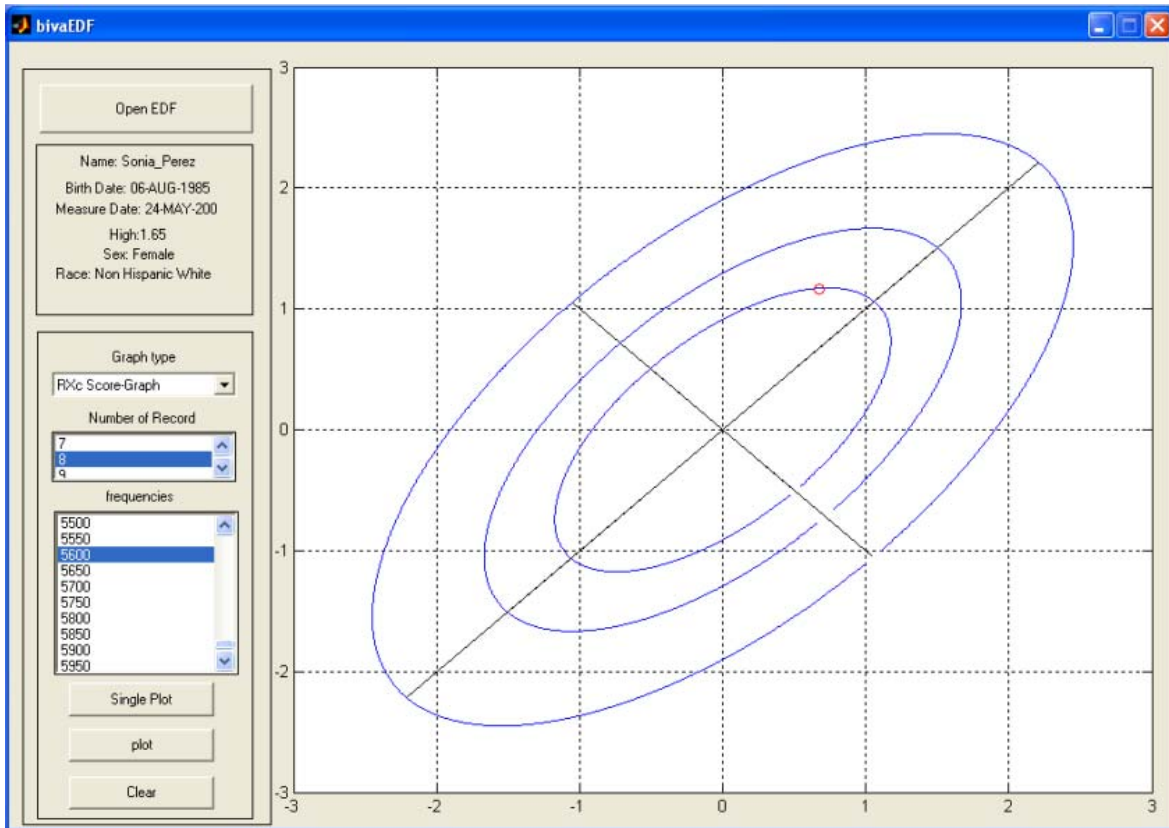

Fig 6.8. Example of the BIVA EDF application for a representation of a BIVA vector point at a single frequency in a desired record.

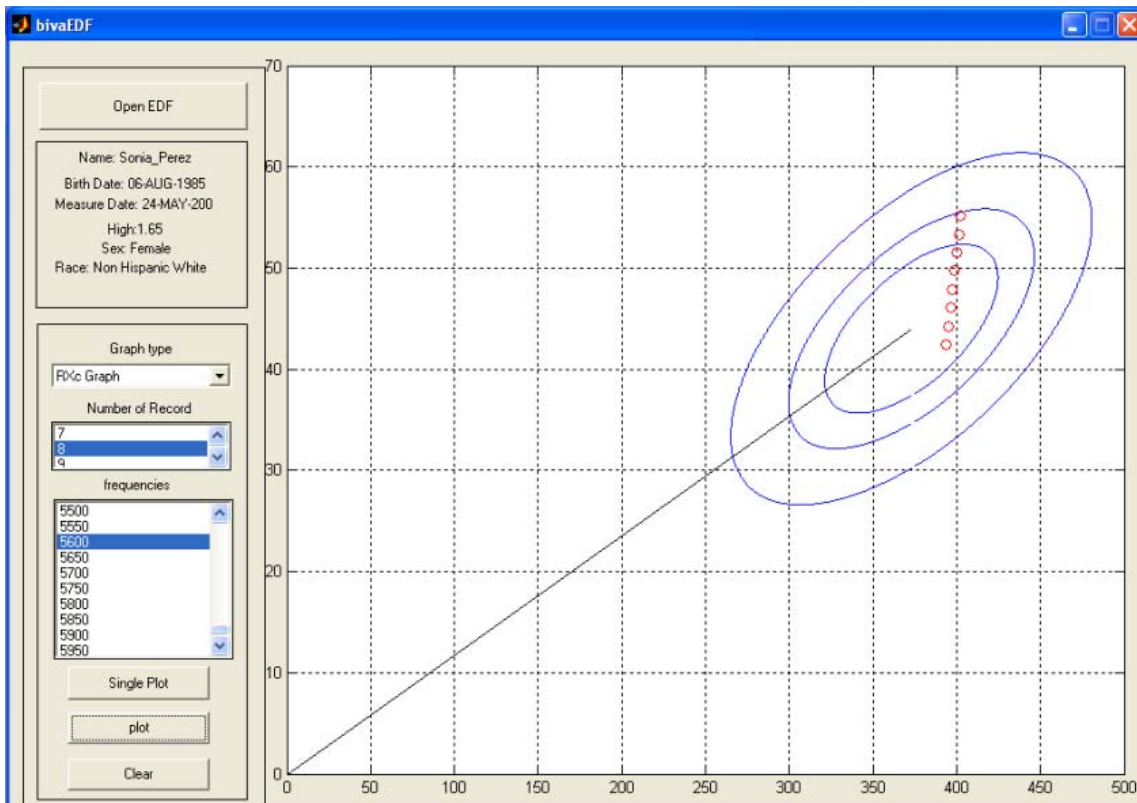

Fig 6.9. Example of the BIVA EDF application for a representation of a BIVA vector point at the different records.

## 6.4 Matlab Subroutines

### 6.4.1. Open EDF Files

```
function[EDFHead, DATAHEAD, RECORD]= EDFOpen()
```

This function allows to open a Bioimpedance EDF format file. When it is called, a common dialog window is open to allow the user to select the location of the file. When the file is selected EDFOpen separates de different fields depending on the headers of the format saving them as strings. The function gives back three structure arrays according to each header. An example of the result of opening a EDF file with the array structure files is shown below.

```
DataHead =
```

```
FILE: [1x1 struct]
FileName: [1x30 char]
Version: '0      '
PID: [1x37 char]
RID: [1x50 char]
SDATE: '24.05.08'
STIME: '20.11.01'
SIZE: '1536'
RES: '1.65 WW'
NDR: '10'
DUR: '0'
NOS: '200'
```

```
DATAHEAD =
```

```
1x200 struct array with fields:
```

```
LABEL
TTYPE
PDIM
MIN
MAX
DMIN
DMAX
PFIL
NSR
RES
```

```
RECORD =
```

```
1x2000 struct array with fields:
```

```
R
```

### 6.4.2. Drawing Ellipses

```
function [] = elipsed(a, b, angle, xd, yd)
```

As we have seen the \_EBI vector analysis is based on tolerance ellipses. This function allows to draw ellipses according to its semi-axis(a, b). Later the rotation matrix is built and the ellipse is rotated a determined angle (angle). This rotated ellipse is moved in the plane to (xd, xy).

### 6.4.3. Implementing RXc Score Graph

```
function[] = RXcscoregraph()
```

This function displays the RXc Score Graph

```
function [L1, L2] = RXc(n, r, F)
```

This function gives back the value of the semi-axis of the RXc Score Graph tolerance ellipse. This value is calculated according to the number of observation pairs (n), the correlation coefficient (r) and the Snedecor's value for the tolerance ellipse probability level(F).

### 6.4.4. Implementing RXc Graph

```
function [L1, L2, alfa] = Celip(n, Sx, Sy, r, F)
```

This function gives back the value of the semi-axis and the rotation angle of the RXc Graph tolerance ellipse. This value is calculated according to the number of observation pairs (n) and its standard deviation (Sx, Sy) The correlation coefficient(r) and the Snedecor's value for the tolerance ellipse probability level.(F)

```
function [] = MNHWhite()
```

This function displays the RXc Graph for a male non-Hispanic white population

```
function [] = WNHWhite()
```

This function displays the RXc Graph for a female non-Hispanic white population

```
function [] = MNHBlack()
```

This function displays the RXc Graph for a male non-Hispanic black population

```
function [] = WNHBlack()
```

This function displays the RXc Graph for a female non-Hispanic black population

```
function [] = MMexican()
```

This function displays the RXc Graph for a male Mexican population

```
function [] = WMexican()
```

This function displays the RXc Graph for a female Mexican population



## CHAPTER 7

### MATLAB RESULTS

#### 7.1. RXc Score Graph

TABLE III: ELLIPSES PARAMETERS FOR RXC SCORE GRAPH

Slope	Major semi axis length ( $\Omega/m$ )			Minor semi axis length ( $\Omega/m$ )		
	95%	75%	50%	95%	75%	50%
45°	3.14	2.13	1.50	1.47	1.00	0.71

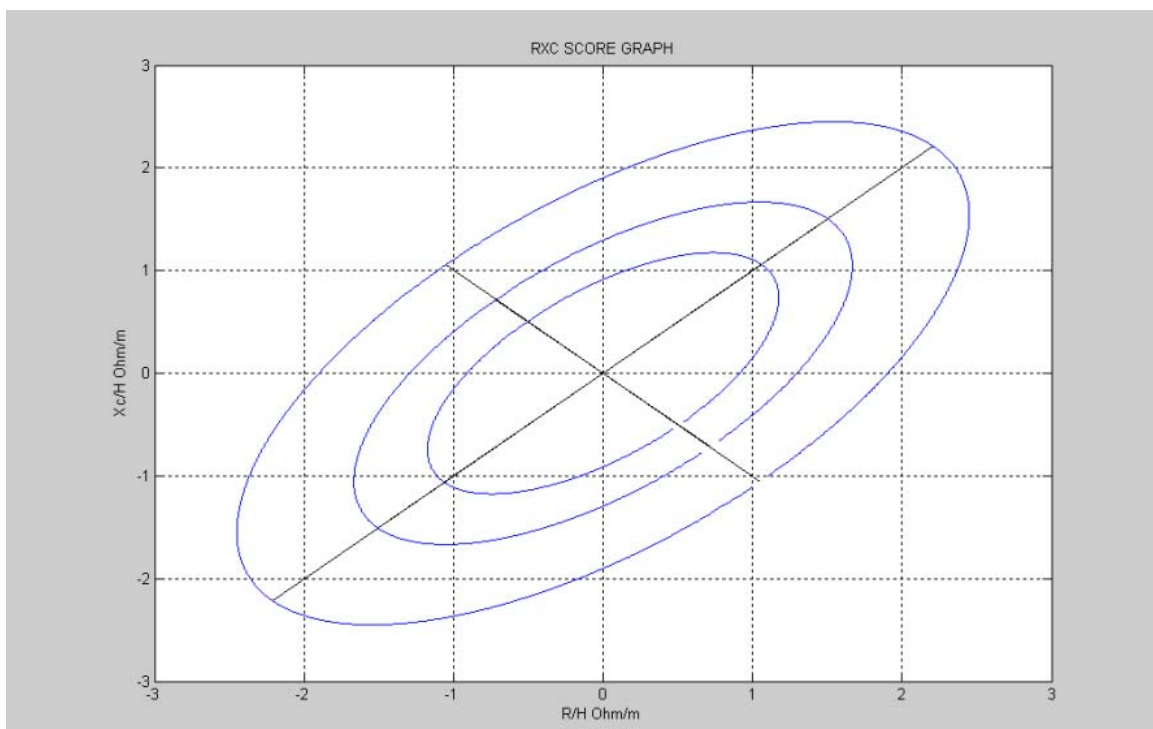

Fig.7.1 RXc Score Graph implemented in Matlab

## 7.2 RXc Graph

### 7.2.1 Men Non-Hispanic White RXc Graph

TABLE III: ELLIPSES PARAMETERS FOR MEN NON HISPANIC WHITE RXC GRAPH

Slope	Major semi axis length ( $\Omega/m$ )			Minor semi axis length ( $\Omega/m$ )		
	95%	75%	50%	95%	75%	50%
45°	82.87	56.4	39.74	12.08	8.22	5.79

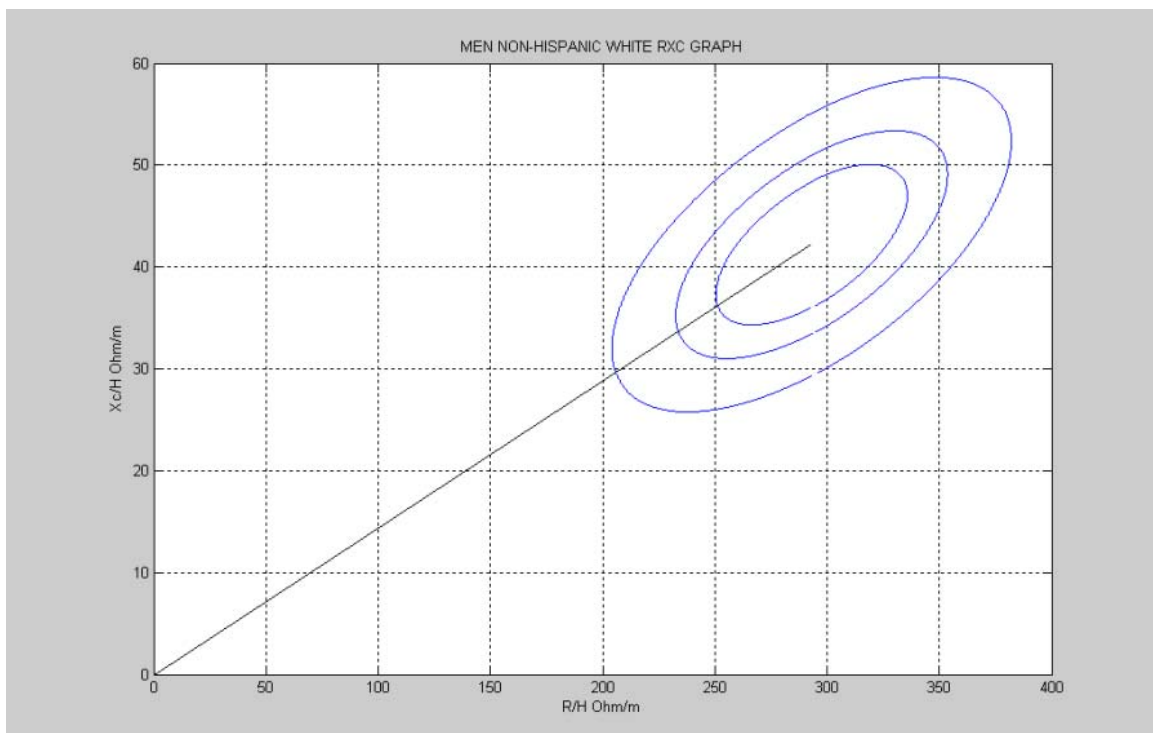

Fig.7.2 RXc Graph for men non-Hispanic white population

## 7.2.2 Women Non-Hispanic White RXc Graph

TABLE III: ELLIPSES PARAMETERS FOR WOMEN NON HISPANIC WHITE RXC GRAPH

Slope	Major semi axis length ( $\Omega/m$ )			Minor semi axis length ( $\Omega/m$ )		
	95%	75%	50%	95%	75%	50%
82.8°	108.37	73.77	51.97	13.72	9.34	6.58

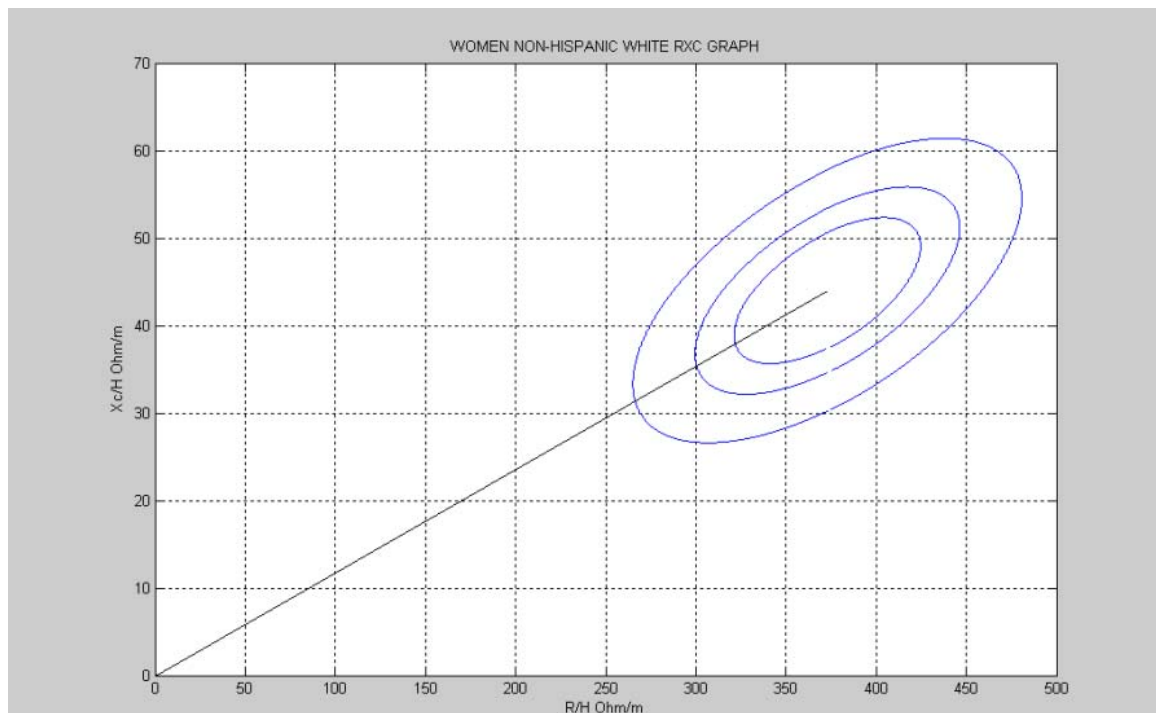

Fig.7.3 RXc Graph for women non-Hispanic white population

### 7.2.3 Men Non-Hispanic Black RXc Graph

TABLE III: ELLIPSES PARAMETERS FOR MEN NON HISPANIC BLACK RXC GRAPH

Slope	Major semi axis length ( $\Omega/m$ )			Minor semi axis length ( $\Omega/m$ )		
	95%	75%	50%	95%	75%	50%
82.9°	92.08	62.68	44,16	13.23	9.01	6.34

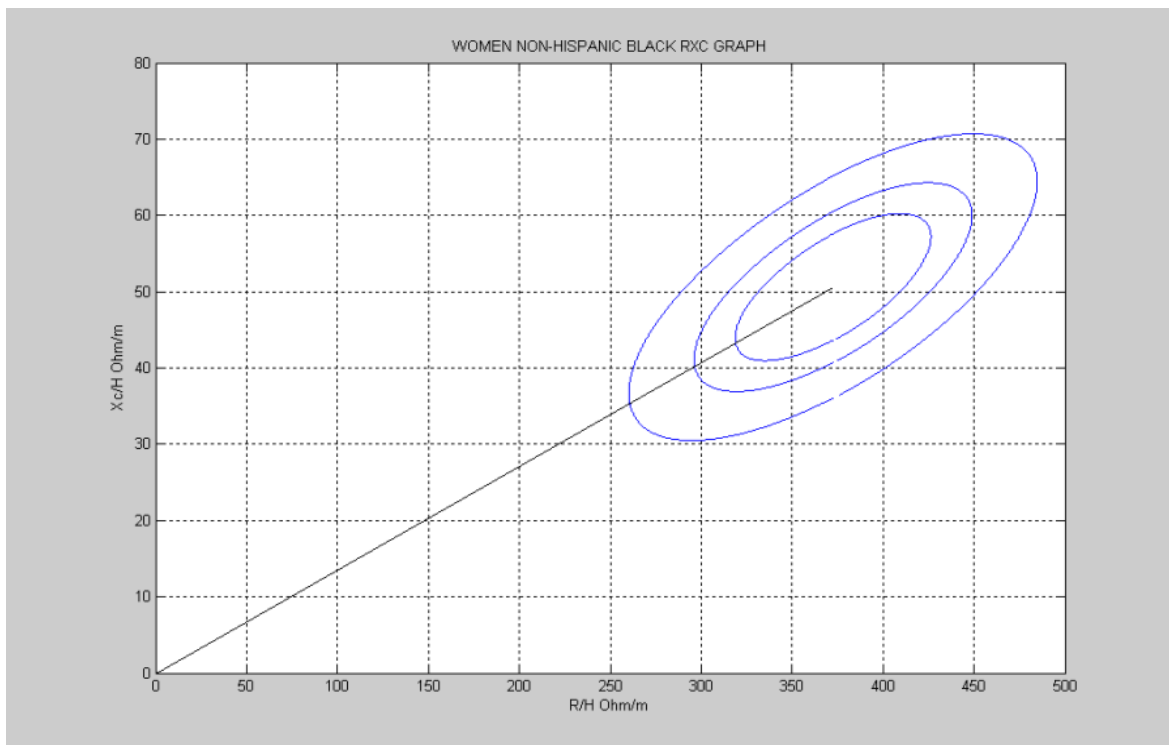

Fig.7.4 RXc Graph for women non-Hispanic black population

### 7.2.4 Women Non-Hispanic Black RXc Graph

TABLE III: ELLIPSES PARAMETERS FOR WOMEN NON HISPANIC BLACK RXC GRAPH

Slope	Major semi axis length ( $\Omega/m$ )			Minor semi axis length ( $\Omega/m$ )		
	95%	75%	50%	95%	75%	50%
82.9°	113.1	77.02	54.26	14.4	9.83	6.95

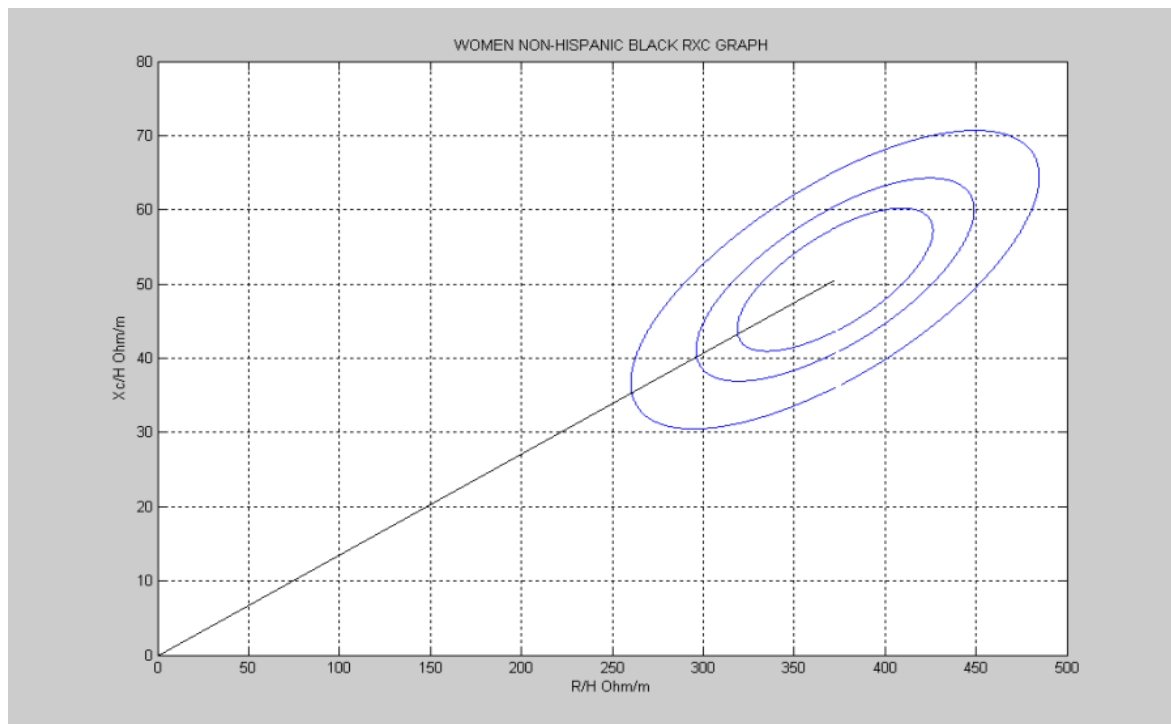

Fig.7.5 RXc Graph for women non-Hispanic black population

### 7.2.5 Men Mexican RXc Graph

TABLE III: ELLIPSES PARAMETERS FOR MEN NON MEXICAN RXC GRAPH

Slope	Major semi axis length ( $\Omega/m$ )			Minor semi axis length ( $\Omega/m$ )		
	95%	75%	50%	95%	75%	50%
82.9°	89.57	60.97	42.96	12.80	8.71	6.14

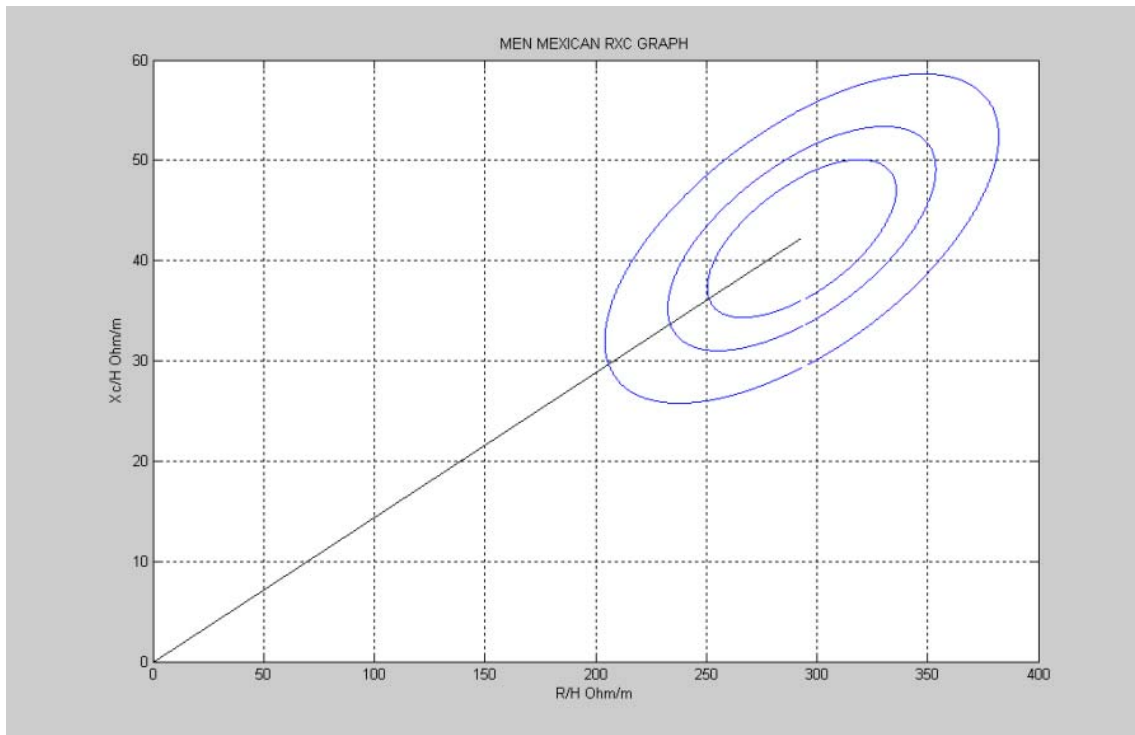

Fig.7.6 RXc Graph for men Mexican population

### 7.2.6 Women Mexican RXc Graph

TABLE III: ELLIPSES PARAMETERS FOR WOMEN MEXICAN RXC GRAPH

Slope	Major semi axis length ( $\Omega/m$ )			Minor semi axis length ( $\Omega/m$ )		
	95%	75%	50%	95%	75%	50%
82.9°	113.03	76.93	54.21	14.81	10.08	7.10

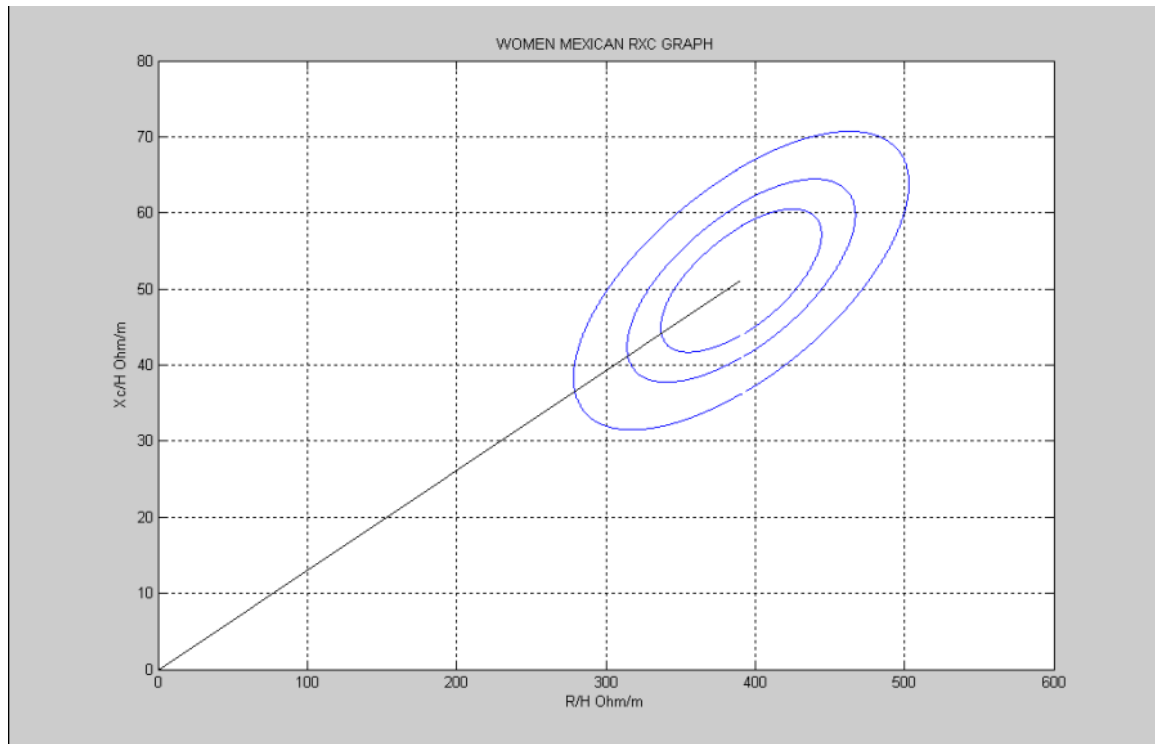

Fig.7.7 RXc Graph for men Mexican population





## **CHAPTER 8**

---

### **DISCUSSION AND FUTURE**

#### **8.1 Discussion**

In this work a software system has been adapted for multifrequency electrical bioimpedance monitoring and an application for EBI data analysis for Body composition has been implemented. This way the initial requirements of the final degree work have been fulfilled.

The EBI data format to save the measurements and the file format open by the analysis application is EDF+. In this manner the data is handled according to a well spread data format.

The Body composition analysis method implemented in the software application is the BIVA (BioImpedance Vector Analysis). The BIVA method has been selected because it is the most well known. Nevertheless, since the measurements are spectral measurements in the frequency range from 3kHz to 100 kHz, other type of body composition analysis could have been implemented e.g. multifrequency analysis, spectral analysis.

For the implementation of these methods the dependence of the method regarding the frequency bandwidth of the measurements must be address. The “limited” bandwidth of the measurement: only 100 kHz,

The analysis tool has been implemented in Matlab, but it could have been implemented in Visual Basic or C++.NET. Since the analysis done might have required specific mathematical processes and functions, the mathematical power of Matlab was an ensuring option.

## 8.2. Future

The work that has been done in this final degree project with the AD5933 evaluation board and the front-end can be seen as a first step for the development of a future practical tool for biomedical measurement, with enhancements to implement.

The first limitation of this EBI measurement system is that the communication is done through the USB and therefore it is connected physically to the computer hosting the software application. To create a wireless application would increase the versatility of usage and would decrease the safety compliance issues. In order to include a wireless communication channel, first of all the power supply to the board that is provided by the USB connection should be changed to a battery. Then the EBI measurement system would be autonomous. This work is being done currently in two other final thesis projects

The data of the measurement is recorded in the hard drive of the computer on which the software is run, so that it can not be easily shared. A telemedicine application can be developed allowing, for example, the data to be sent to an external web server where different clients can access the recorded measurements

The Matlab application was created as a research tool for the BIVA analysis of the recorded data. This is actually one of the most popular bioimpedance analysis techniques, but not the only one. Matlab allows an easy implementation for other types of analysis of the data that can easily be integrated into the system, allowing further analysis. Among the possible analysis approaches to be added to the matlab application there are three of special interest:

- Cole-based analysis
- Multifrequency analysis
- Spectral Feature analysis

This work has generated two independent but complementary software applications; it would certainly be an improvement if both the EBI measurement application and the

EBI data analysis would be integrated in a single software application. This way the dependency of Matlab would eliminate.



## REFERENCES

---

- [1] Piccoli A., P. L., Dumbler F. “Impedance Vector Distribution by Sex, Race, Body Mass Index, and Age in the United States: Standard Reference Intervals as Bivariate Z Scores”. (2002).
- [2] Lexa Nescolarde Selva “Segmental and Whole Body Electrical Impedance Measurements in Dialysis Patients”. PhD Thesis. Universidad Politécnica de Barcelona. (2006).
- [3] R. Dorhofer, PD Dr. Med. Mattias Pirlich(2005). “The B.I.A. Compendium” Data Input GmbH..
- [4] J. Ferreira, J. J. Sánchez. “Electrical Bioimpedance Measurement System for Limb Oedema Monitoring”. Final degree thesis. School of Engineering University Collage of Borås. (2007).
- [5] F. Seoane, J. Ferreira, J.J. Sánchez, R. Bragos. “Analog Front-End enables electrical impedance spectroscopy system on-chip for biomedical applications.” Physiological measurements. Accepted for publication. (2008).
- [6] WHO Expert Committee on Physical Status “The use and interpretation of anthropometry”. *Technical Report 854*, World Health Organization, Geneva (1995).
- [7] US Department of Agriculture, Agricultural Research Service, Dietary Guidelines Advisory Committee. “*Report of the Dietary Guidelines Advisory Committee on the Dietary Guidelines for Americans*” to the Secretary of Health and Human Services and the Secretary of Agriculture, US Department of Agriculture, Beltsville, MD (1995).